



**COMMONWEALTH OF PENNSYLVANIA
DEPARTMENT OF ENVIRONMENTAL PROTECTION
AIR QUALITY PROGRAM**

STATE ONLY SYNTHETIC MINOR OPERATING PERMIT

Issue Date: July 30, 2024

Effective Date: July 30, 2024

Expiration Date: July 29, 2029

In accordance with the provisions of the Air Pollution Control Act, the Act of January 8, 1960, P.L. 2119, as amended, and 25 Pa. Code Chapter 127, the Owner, [and Operator if noted] (hereinafter referred to as permittee) identified below is authorized by the Department of Environmental Protection (Department) to operate the air emission source(s) more fully described in this permit. This Facility is subject to all terms and conditions specified in this permit. Nothing in this permit relieves the permittee from its obligations to comply with all applicable Federal, State and Local laws and regulations.

The regulatory or statutory authority for each permit condition is set forth in brackets. All terms and conditions in this permit are federally enforceable unless otherwise designated.

State Only Permit No: 49-00054

Synthetic Minor

Federal Tax Id - Plant Code: 23-1669932-1

Owner Information

Name: MECKLEYS LIMESTONE PROD INC

Mailing Address: PO BOX 503

HERNDON, PA 17830-0503

Plant Information

Plant: MECKLEYS LIMESTONE PROD/HERNDON QUARRY

Location: 49 Northumberland County

49918 Lower Mahanoy Township

SIC Code: 1422 Mining - Crushed And Broken Limestone

Responsible Official

Name: MATTHEW G MARKUNAS

Title: PRES

Phone: (570) 758 - 3011

Email: mmich@ptd.net

Permit Contact Person

Name: KEVIN FICK

Title: OPERATIONS MANAGER

Phone: (570) 758 - 3011 Ext.131

Email: kfick@ptd.net

[Signature] _____

MUHAMMAD Q. ZAMAN, ENVIRONMENTAL PROGRAM MANAGER, NORTHCENTRAL REGION



SECTION A. Table of Contents

Section A. Facility/Source Identification

Table of Contents
Site Inventory List

Section B. General State Only Requirements

- #001 Definitions.
- #002 Operating Permit Duration.
- #003 Permit Renewal.
- #004 Operating Permit Fees under Subchapter I.
- #005 Transfer of Operating Permits.
- #006 Inspection and Entry.
- #007 Compliance Requirements.
- #008 Need to Halt or Reduce Activity Not a Defense.
- #009 Duty to Provide Information.
- #010 Revising an Operating Permit for Cause.
- #011 Operating Permit Modifications
- #012 Severability Clause.
- #013 De Minimis Emission Increases.
- #014 Operational Flexibility.
- #015 Reactivation of Sources
- #016 Health Risk-based Emission Standards and Operating Practice Requirements.
- #017 Circumvention.
- #018 Reporting Requirements.
- #019 Sampling, Testing and Monitoring Procedures.
- #020 Recordkeeping.
- #021 Property Rights.
- #022 Alternative Operating Scenarios.
- #023 Reporting
- #024 Report Format

Section C. Site Level State Only Requirements

- C-I: Restrictions
- C-II: Testing Requirements
- C-III: Monitoring Requirements
- C-IV: Recordkeeping Requirements
- C-V: Reporting Requirements
- C-VI: Work Practice Standards
- C-VII: Additional Requirements
- C-VIII: Compliance Certification
- C-IX: Compliance Schedule

Section D. Source Level State Only Requirements

- D-I: Restrictions
- D-II: Testing Requirements
- D-III: Monitoring Requirements
- D-IV: Recordkeeping Requirements
- D-V: Reporting Requirements
- D-VI: Work Practice Standards
- D-VII: Additional Requirements

Note: These same sub-sections are repeated for each source!

Section E. Source Group Restrictions

- E-I: Restrictions



SECTION A. Table of Contents

- E-II: Testing Requirements
- E-III: Monitoring Requirements
- E-IV: Recordkeeping Requirements
- E-V: Reporting Requirements
- E-VI: Work Practice Standards
- E-VII: Additional Requirements

Section F. Alternative Operating Scenario(s)

- F-I: Restrictions
- F-II: Testing Requirements
- F-III: Monitoring Requirements
- F-IV: Recordkeeping Requirements
- F-V: Reporting Requirements
- F-VI: Work Practice Standards
- F-VII: Additional Requirements

Section G. Emission Restriction Summary

Section H. Miscellaneous

**SECTION A. Site Inventory List**

Source ID	Source Name	Capacity/Throughput	Fuel/Material
031	GARAGE FURNACE	0.400 MMBTU/HR	
		2.850 Gal/HR	#2 FUEL OIL
P101	HAUL ROADS		
P102	PRIMARY CRUSHING AREA	200.000 Tons/HR	AGGREGATES
P103	SECONDARY CRUSHING AREA	200.000 Tons/HR	AGGREGATES
P104	PULVERIZED LIMESTONE DRYING SYSTEM	100.000 Tons/HR	AGGREGATES
P105	LIMESTONE PULVERIZING AND STORAGE SYSTEM	100.000 Tons/HR	AGGREGATES
P106	LIMESTONE DUST BUNKER		
P201	ASPHALT CONCRETE PLANT	180.000 Tons/HR	ASPHALT CEMENT
P301	FIVE (5) ABOVEGROUND STORAGE TANKS		
P302	ONE (1) PARTS CLEANING STATION		
P401	PORTABLE SCREENING		
C102	PRIMARY CRUSHING DUST COLLECTOR		
C103	SECONDARY CRUSHING DUST COLLECTOR		
C104A	CYCLONE SEPARATOR		
C104B	PULVERIZED LIMESTONE DRYING DUST COLLECTOR		
C105A	SILO #6 BIN VENT FILTER		
C105B	SILO #1, 2, 3, AND 4 BIN VENT FILTER		
C105C	SILO #7 BIN VENT FILTER		
C105D	SILO #8 BIN VENT FILTER		
C105E	DUST SILO FABRIC COLLECTOR		
C105F	PULVERIZED LIMESTONE AND STORAGE SYSTEM DUST COLLECTOR		
C106	DUST BUNKER BIN VENT FILTER		
C140	WATER SPRAY DUST SUPPRESION SYSTEM		
C141	SURFACTANT FOAM DUST SUPPRESION SYSTEM		
C201A	ASPHALT PLANT DUST COLLECTOR		
C201B	ASPHALT DUST SILO DUST COLLECTOR		
DIESEL	DIESEL FUEL		
FM01	GARAGE FURNACE TANK		
FM02	ASPHALT BURNER/PUG MILL HEATER TANK		
FM03	STONE DRYER STORAGE TANK		
S031	GARAGE FURNACE STACK		
S102	PRIMARY CRUSHING DUST COLLECTOR STACK		
S103	SECONDARY CRUSHING DUST COLLECTOR STACK		
S104	PULVERIZED LIMESTONE DUST COLLECTOR STACK		
S105A	SILO #6 BIN VENT FILTER STACK		
S105B	SILO #1, 2, 3, AND 4 BIN VENT FILTER STACK		
S105C	SILO #7 BIN VENT FILTER STACK		
S105D	SILO #8 BIN VENT FILTER STACK		

**SECTION A. Site Inventory List**

Source ID	Source Name	Capacity/Throughput	Fuel/Material
S105E	DUST SILO DUST COLLECTOR STACK		
S105F	DUST COLLECTOR STACK		
S106	BIN VENT FILTER STACK		
S201	ASPHALT PLANT DUST COLLECTOR STACK		
S401	SCREENER-ENGINE EXHAUST		
Z01	FUGITIVE EMISSIONS		
Z401	SCREENING OPERATION		

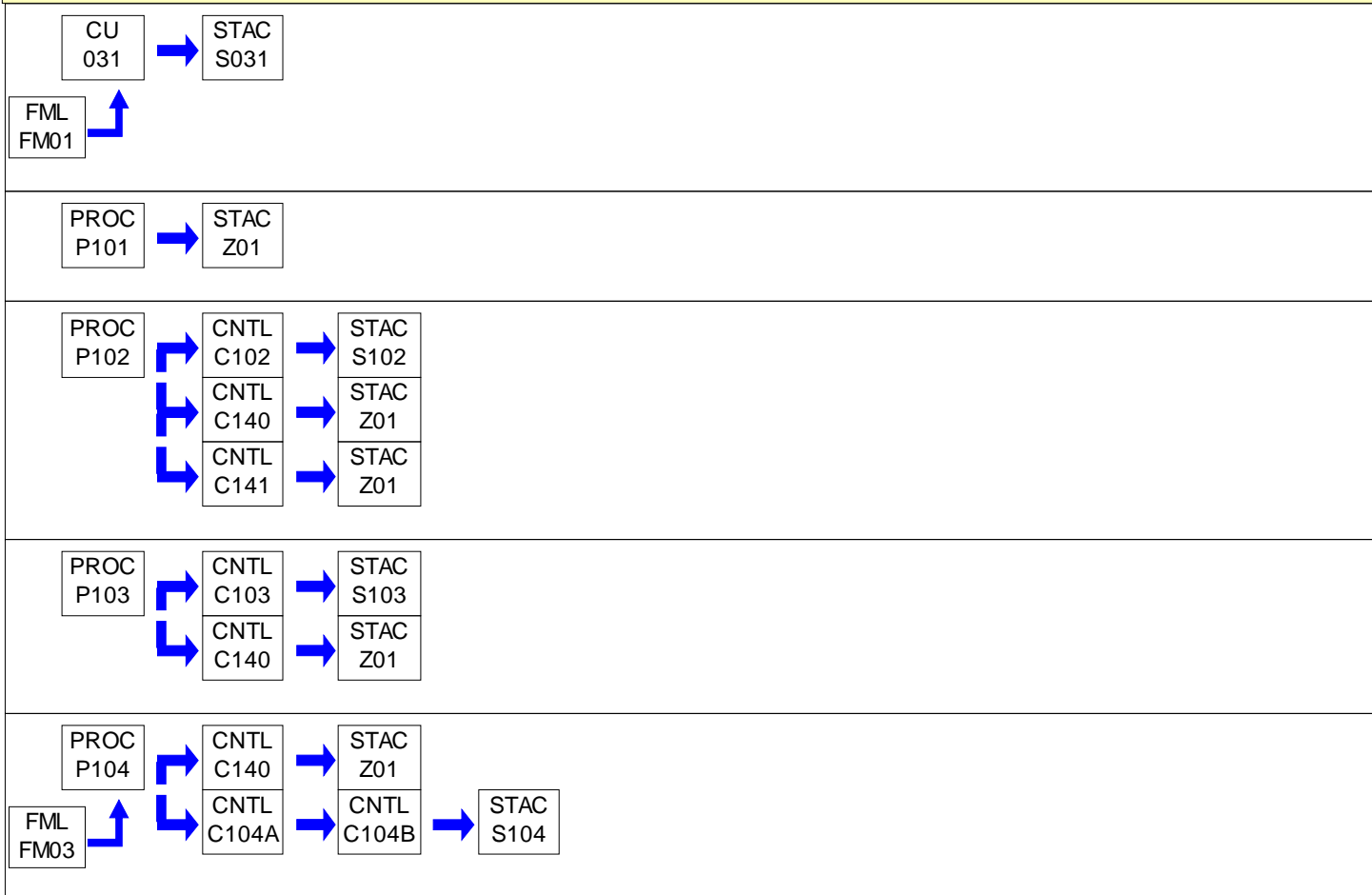
PERMIT MAPS



PERMIT MAPS

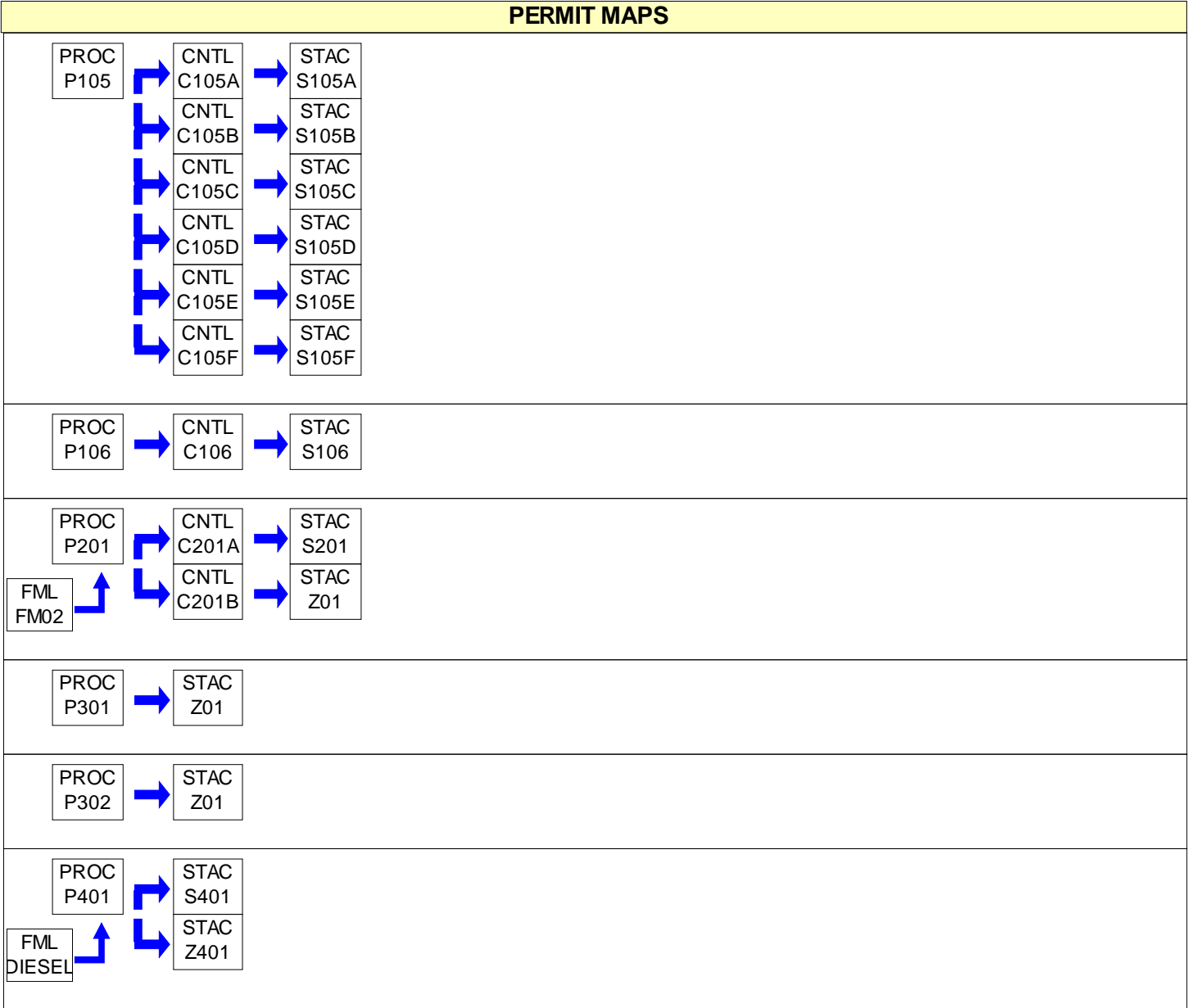

**SECTION B. General State Only Requirements****#001 [25 Pa. Code § 121.1]****Definitions.**

Words and terms that are not otherwise defined in this permit shall have the meanings set forth in Section 3 of the Air Pollution Control Act (35 P.S. § 4003) and in 25 Pa. Code § 121.1.

#002 [25 Pa. Code § 127.446]**Operating Permit Duration.**

(a) This operating permit is issued for a fixed term of five (5) years and shall expire on the date specified on Page 1 of this permit.

(b) The terms and conditions of the expired permit shall automatically continue pending issuance of a new operating permit, provided the permittee has submitted a timely and complete application and paid applicable fees required under 25 Pa. Code Chapter 127, Subchapter I and the Department is unable, through no fault of the permittee, to issue or deny a new permit before the expiration of the previous permit.

#003 [25 Pa. Code §§ 127.412, 127.413, 127.414, 127.446 & 127.703(b)]**Permit Renewal.**

(a) The permittee shall submit a timely and complete application for renewal of the operating permit to the appropriate Regional Air Program Manager. The application for renewal of the operating permit shall be submitted at least six (6) months and not more than 18 months before the expiration date of this permit.

(b) The application for permit renewal shall include the current permit number, a description of any permit revisions that occurred during the permit term, and any applicable requirements that were promulgated and not incorporated into the permit during the permit term. An application is complete if it contains sufficient information to begin processing the application, has the applicable sections completed and has been signed by a responsible official.

(c) The permittee shall submit with the renewal application a fee for the processing of the application as specified in 25 Pa. Code § 127.703(b). The fees shall be made payable to "The Commonwealth of Pennsylvania Clean Air Fund" and submitted with the fee form to the respective regional office.

(d) The renewal application shall also include submission of proof that the local municipality and county, in which the facility is located, have been notified in accordance with 25 Pa. Code § 127.413.

(e) The application for renewal of the operating permit shall also include submission of supplemental compliance review forms in accordance with the requirements of 25 Pa. Code § 127.412(b) and § 127.412(j).

(f) The permittee, upon becoming aware that any relevant facts were omitted or incorrect information was submitted in the permit application, shall promptly submit such supplementary facts or corrected information as necessary to address any requirements that become applicable to the source after the permittee submits a complete application, but prior to the date the Department takes action on the permit application.

#004 [25 Pa. Code § 127.703]**Operating Permit Fees under Subchapter I.**

(a) The permittee shall pay the annual operating permit maintenance fee according to the following fee schedule in either paragraph (1) or (2) in accordance with 25 Pa. Code § 127.703(d) on or before December 31 of each year for the next calendar year.

(1) For a synthetic minor facility, a fee equal to:

(i) Four thousand dollars (\$4,000) for calendar years 2021—2025.

(ii) Five thousand dollars (\$5,000) for calendar years 2026—2030.

(iii) Six thousand three hundred dollars (\$6,300) for the calendar years beginning with 2031.

**SECTION B. General State Only Requirements**

(2) For a facility that is not a synthetic minor, a fee equal to:

- (i) Two thousand dollars (\$2,000) for calendar years 2021—2025.
- (ii) Two thousand five hundred dollars (\$2,500) for calendar years 2026—2030.
- (iii) Three thousand one hundred dollars (\$3,100) for the calendar years beginning with 2031.

(b) The applicable fees shall be made payable to "The Commonwealth of Pennsylvania Clean Air Fund" with the permit number clearly indicated and submitted to the respective regional office.

#005 [25 Pa. Code §§ 127.450 (a)(4) and 127.464]**Transfer of Operating Permits.**

(a) This operating permit may not be transferred to another person, except in cases of transfer-of-ownership that are documented and approved by the Department.

(b) In accordance with 25 Pa. Code § 127.450(a)(4), a change in ownership of the source shall be treated as an administrative amendment if the Department determines that no other change in the permit is required and a written agreement has been submitted to the Department identifying the specific date of the transfer of permit responsibility, coverage and liability between the current and the new permittee and a compliance review form has been submitted to, and the permit transfer has been approved by, the Department.

(c) This operating permit is valid only for those specific sources and the specific source locations described in this permit.

#006 [25 Pa. Code § 127.441 and 35 P.S. § 4008]**Inspection and Entry.**

(a) Upon presentation of credentials and other documents as may be required by law, the permittee shall allow the Department or authorized representatives of the Department to perform the following:

(1) Enter at reasonable times upon the permittee's premises where a source is located or emissions related activity is conducted, or where records are kept under the conditions of this permit;

(2) Have access to and copy, at reasonable times, any records that are kept under the conditions of this permit;

(3) Inspect at reasonable times, any facilities, equipment including monitoring and air pollution control equipment, practices, or operations regulated or required under this permit;

(4) Sample or monitor, at reasonable times, any substances or parameters, for the purpose of assuring compliance with the permit or applicable requirements as authorized by the Clean Air Act, the Air Pollution Control Act, or the regulations promulgated under the Acts.

(b) Pursuant to 35 P.S. § 4008, no person shall hinder, obstruct, prevent or interfere with the Department or its personnel in the performance of any duty authorized under the Air Pollution Control Act or regulations adopted thereunder including denying the Department access to a source at this facility. Refusal of entry or access may constitute grounds for permit revocation and assessment of criminal and/or civil penalties.

(c) Nothing in this permit condition shall limit the ability of the EPA to inspect or enter the premises of the permittee in accordance with Section 114 or other applicable provisions of the Clean Air Act.

#007 [25 Pa. Code §§ 127.441 & 127.444]**Compliance Requirements.**

(a) The permittee shall comply with the conditions of this operating permit. Noncompliance with this permit constitutes a violation of the Clean Air Act and the Air Pollution Control Act and is grounds for one or more of the following:

**SECTION B. General State Only Requirements**

- (1) Enforcement action
- (2) Permit termination, revocation and reissuance or modification
- (3) Denial of a permit renewal application

(b) A person may not cause or permit the operation of a source which is subject to 25 Pa. Code Article III unless the source(s) and air cleaning devices identified in the application for the plan approval and operating permit and the plan approval issued for the source is operated and maintained in accordance with specifications in the applications and the conditions in the plan approval and operating permit issued by the Department. A person may not cause or permit the operation of an air contamination source subject to 25 Pa. Code Chapter 127 in a manner inconsistent with good operating practices.

(c) For purposes of Sub-condition (b) of this permit condition, the specifications in applications for plan approvals and operating permits are the physical configurations and engineering design details which the Department determines are essential for the permittee's compliance with the applicable requirements in this State-Only permit. Nothing in this sub-condition shall be construed to create an independent affirmative duty upon the permittee to obtain a predetermination from the Department for physical configuration or engineering design detail changes made by the permittee.

#008 [25 Pa. Code § 127.441]**Need to Halt or Reduce Activity Not a Defense.**

It shall not be a defense for the permittee in an enforcement action that it was necessary to halt or reduce the permitted activity in order to maintain compliance with the conditions of this permit.

#009 [25 Pa. Code §§ 127.442(a) & 127.461]**Duty to Provide Information.**

(a) The permittee shall submit reports to the Department containing information the Department may prescribe relative to the operation and maintenance of each source at the facility.

(b) The permittee shall furnish to the Department, in writing, information that the Department may request to determine whether cause exists for modifying, revoking and reissuing, or terminating this permit, or to determine compliance with the permit. Upon request, the permittee shall also furnish to the Department copies of records that the permittee is required to maintain in accordance with this permit.

#010 [25 Pa. Code § 127.461]**Revising an Operating Permit for Cause.**

This operating permit may be terminated, modified, suspended or revoked and reissued if one or more of the following applies:

- (1) The permittee constructs or operates the source subject to the operating permit so that it is in violation of the Air Pollution Control Act, the Clean Air Act, the regulations thereunder, a plan approval, a permit or in a manner that causes air pollution.
- (2) The permittee fails to properly or adequately maintain or repair an air pollution control device or equipment attached to or otherwise made a part of the source.
- (3) The permittee has failed to submit a report required by the operating permit or an applicable regulation.
- (4) The EPA determines that the permit is not in compliance with the Clean Air Act or the regulations thereunder.

#011 [25 Pa. Code §§ 127.450, 127.462, 127.465 & 127.703]**Operating Permit Modifications**

(a) The permittee is authorized to make administrative amendments, minor operating permit modifications and significant operating permit modifications, under this permit, as outlined below:

**SECTION B. General State Only Requirements**

(b) Administrative Amendments. The permittee shall submit the application for administrative operating permit amendments (as defined in 25 Pa. Code § 127.450(a)), according to procedures specified in § 127.450 unless precluded by the Clean Air Act or its regulations.

(c) Minor Operating Permit Modifications. The permittee shall submit the application for minor operating permit modifications (as defined 25 Pa. Code § 121.1) in accordance with 25 Pa. Code § 127.462.

(d) Significant Operating Permit Modifications. The permittee shall submit the application for significant operating permit modifications in accordance with 25 Pa. Code § 127.465.

(e) The applicable fees shall be made payable to "The Commonwealth of Pennsylvania Clean Air Fund" with the permit number clearly indicated and submitted to the respective regional office.

#012 [25 Pa. Code § 127.441]**Severability Clause.**

The provisions of this permit are severable, and if any provision of this permit is determined by a court of competent jurisdiction to be invalid or unenforceable, such a determination will not affect the remaining provisions of this permit.

#013 [25 Pa. Code § 127.449]**De Minimis Emission Increases.**

(a) This permit authorizes de minimis emission increases in accordance with 25 Pa. Code § 127.449 so long as the permittee provides the Department with seven (7) days prior written notice before commencing any de minimis emissions increase. The written notice shall:

(1) Identify and describe the pollutants that will be emitted as a result of the de minimis emissions increase.

(2) Provide emission rates expressed in tons per year and in terms necessary to establish compliance consistent with any applicable requirement.

(b) The Department may disapprove or condition de minimis emission increases at any time.

(c) Except as provided below in (d), the permittee is authorized to make de minimis emission increases (expressed in tons per year) up to the following amounts without the need for a plan approval or prior issuance of a permit modification:

(1) Four tons of carbon monoxide from a single source during the term of the permit and 20 tons of carbon monoxide at the facility during the term of the permit.

(2) One ton of NO_x from a single source during the term of the permit and 5 tons of NO_x at the facility during the term of the permit.

(3) One and six-tenths tons of the oxides of sulfur from a single source during the term of the permit and 8.0 tons of oxides of sulfur at the facility during the term of the permit.

(4) Six-tenths of a ton of PM₁₀ from a single source during the term of the permit and 3.0 tons of PM₁₀ at the facility during the term of the permit. This shall include emissions of a pollutant regulated under Section 112 of the Clean Air Act unless precluded by the Clean Air Act, the regulations thereunder or 25 Pa. Code Article III.

(5) One ton of VOCs from a single source during the term of the permit and 5.0 tons of VOCs at the facility during the term of the permit. This shall include emissions of a pollutant regulated under Section 112 of the Clean Air Act unless precluded by the Clean Air Act, the regulations thereunder or 25 Pa. Code Article III.

(6) Other sources and classes of sources determined to be of minor significance by the Department.

(d) In accordance with § 127.14, the permittee is authorized to install the following minor sources without the need for a plan approval or permit modification:

**SECTION B. General State Only Requirements**

- (1) Air conditioning or ventilation systems not designed to remove pollutants generated or released from other sources.
- (2) Combustion units rated at 2,500,000 or less Btu per hour of heat input.
- (3) Combustion units with a rated capacity of less than 10,000,000 Btu per hour heat input fueled by natural gas supplied by a public utility or by commercial fuel oils which are No. 2 or lighter, viscosity less than or equal to 5.82 c St, and which meet the sulfur content requirements of 25 Pa. Code §123.22 (relating to combustion units). For purposes of this permit, commercial fuel oil shall be virgin oil which has no reprocessed, recycled or waste material added.
- (4) Space heaters which heat by direct heat transfer.
- (5) Laboratory equipment used exclusively for chemical or physical analysis.
- (6) Other sources and classes of sources determined to be of minor significance by the Department.
- (e) This permit does not authorize de minimis emission increases if the emissions increase would cause one or more of the following:
- (1) Increase the emissions of a pollutant regulated under Section 112 of the Clean Air Act except as authorized in Subparagraphs (c)(4) and (5) of this permit condition.
- (2) Subject the facility to the prevention of significant deterioration requirements in 25 Pa. Code Chapter 127, Subchapter D and/or the new source review requirements in Subchapter E.
- (3) Violate any applicable requirement of this permit, the Air Pollution Control Act, the Clean Air Act, or the regulations promulgated under either of the acts.
- (f) Emissions authorized under this permit condition shall be included in the monitoring, recordkeeping and reporting requirements of this permit.
- (g) Except for de minimis emission increases, installation of minor sources made pursuant to this permit condition and Plan Approval Exemptions under 25 Pa. Code § 127.14 (relating to exemptions), the permittee is prohibited from making changes or engaging in activities that are not specifically authorized under this permit without first applying for a plan approval. In accordance with § 127.14(b), a plan approval is not required for the construction, modification, reactivation, or installation of the sources creating the de minimis emissions increase.
- (h) The permittee may not meet de minimis emission threshold levels by offsetting emission increases or decreases at the same source.

#014 [25 Pa. Code § 127.3]**Operational Flexibility.**

The permittee is authorized to make changes within the facility in accordance with the regulatory provisions outlined in 25 Pa. Code § 127.3 (relating to operational flexibility) to implement the operational flexibility requirements provisions authorized under Section 6.1(i) of the Air Pollution Control Act and the operational flexibility terms and conditions of this permit. The provisions in 25 Pa. Code Chapter 127 which implement the operational flexibility requirements include the following:

- (1) Section 127.14 (relating to exemptions)
- (2) Section 127.447 (relating to alternative operating scenarios)
- (3) Section 127.448 (relating to emissions trading at facilities with Federally enforceable emissions caps)
- (4) Section 127.449 (relating to de minimis emission increases)
- (5) Section 127.450 (relating to administrative operating permit amendments)

**SECTION B. General State Only Requirements**

(6) Section 127.462 (relating to minor operating permit modifications)

(7) Subchapter H (relating to general plan approvals and general operating permits)

#015 [25 Pa. Code § 127.11a]**Reactivation of Sources**

(a) The permittee may not reactivate a source that has been out of operation or production for at least one year unless the reactivation is conducted in accordance with a plan approval granted by the Department or in accordance with reactivation and maintenance plans developed and approved by the Department in accordance with 25 Pa. Code § 127.11a(a).

(b) A source which has been out of operation or production for more than five (5) years but less than 10 years may be reactivated and will not be considered a new source if the permittee satisfies the conditions specified in 25 Pa. Code § 127.11a(b).

#016 [25 Pa. Code § 127.36]**Health Risk-based Emission Standards and Operating Practice Requirements.**

(a) When needed to protect public health, welfare and the environment from emissions of hazardous air pollutants from new and existing sources, the permittee shall comply with the health risk-based emission standards or operating practice requirements imposed by the Department, except as precluded by §§ 6.6(d)(2) and (3) of the Air Pollution Control Act [35 P.S. § 4006.6(d)(2) and (3)].

(b) A person challenging a performance or emission standard established by the Department has the burden to demonstrate that performance or emission standard does not meet the requirements of Section 112 of the Clean Air Act.

#017 [25 Pa. Code § 121.9]**Circumvention.**

No person may permit the use of a device, stack height which exceeds good engineering practice stack height, dispersion technique or other technique which, without resulting in reduction of the total amount of air contaminants emitted, conceals or dilutes an emission of air contaminants which would otherwise be in violation of 25 Pa. Code Article III, except that with prior approval of the Department, the device or technique may be used for control of malodors.

#018 [25 Pa. Code §§ 127.402(d) & 127.442]**Reporting Requirements.**

(a) The permittee shall comply with the applicable reporting requirements of the Clean Air Act, the regulations thereunder, the Air Pollution Control Act and 25 Pa. Code Article III including Chapters 127, 135 and 139.

(b) The permittee shall submit reports to the Department containing information the Department may prescribe relative to the operation and maintenance of any air contamination source.

(c) Reports, test data, monitoring data, notifications and requests for renewal of the permit shall be submitted to the:

Regional Air Program Manager
PA Department of Environmental Protection
(At the address given in the permit transmittal letter, or otherwise notified)

(d) Any records or information including applications, forms, or reports submitted pursuant to this permit condition shall contain a certification by a responsible official as to truth, accuracy and completeness. The certifications submitted under this permit shall require a responsible official of the facility to certify that based on information and belief formed after reasonable inquiry, the statements and information in the documents are true, accurate and complete.

(e) Any records, reports or information submitted to the Department shall be available to the public except for such

**SECTION B. General State Only Requirements**

records, reports or information which meet the confidentiality requirements of § 4013.2 of the Air Pollution Control Act and §§ 112(d) and 114(c) of the Clean Air Act. The permittee may not request a claim of confidentiality for any emissions data generated for the facility.

#019 [25 Pa. Code §§ 127.441(c) & 135.5]**Sampling, Testing and Monitoring Procedures.**

(a) The permittee shall comply with the monitoring, recordkeeping or reporting requirements of 25 Pa. Code Chapter 139 and the other applicable requirements of 25 Pa. Code Article III and additional requirements related to monitoring, reporting and recordkeeping required by the Clean Air Act and the regulations thereunder including the Compliance Assurance Monitoring requirements of 40 CFR Part 64, where applicable.

(b) Unless alternative methodology is required by the Clean Air Act and regulations adopted thereunder, sampling, testing and monitoring required by or used by the permittee to demonstrate compliance with any applicable regulation or permit condition shall be conducted in accordance with the requirements of 25 Pa. Code Chapter 139.

#020 [25 Pa. Code §§ 127.441(c) and 135.5]**Recordkeeping.**

(a) The permittee shall maintain and make available, upon request by the Department, the following records of monitored information:

- (1) The date, place (as defined in the permit) and time of sampling or measurements.
- (2) The dates the analyses were performed.
- (3) The company or entity that performed the analyses.
- (4) The analytical techniques or methods used.
- (5) The results of the analyses.
- (6) The operating conditions as existing at the time of sampling or measurement.

(b) The permittee shall retain records of any required monitoring data and supporting information for at least five (5) years from the date of the monitoring, sample, measurement, report or application. Supporting information includes the calibration data and maintenance records and original strip-chart recordings for continuous monitoring instrumentation, and copies of reports required by the permit.

(c) The permittee shall maintain and make available to the Department upon request, records including computerized records that may be necessary to comply with the reporting, recordkeeping and emission statement requirements in 25 Pa. Code Chapter 135 (relating to reporting of sources). In accordance with 25 Pa. Code Chapter 135, § 135.5, such records may include records of production, fuel usage, maintenance of production or pollution control equipment or other information determined by the Department to be necessary for identification and quantification of potential and actual air contaminant emissions.

#021 [25 Pa. Code § 127.441(a)]**Property Rights.**

This permit does not convey any property rights of any sort, or any exclusive privileges.

#022 [25 Pa. Code § 127.447]**Alternative Operating Scenarios.**

The permittee is authorized to make changes at the facility to implement alternative operating scenarios identified in this permit in accordance with 25 Pa. Code § 127.447.

**SECTION B. General State Only Requirements****#023 [25 Pa. Code §135.3]****Reporting**

(a) If the facility is a Synthetic Minor Facility, the permittee shall submit by March 1 of each year an annual emissions report for the preceding calendar year. The report shall include information for all active previously reported sources, new sources which were first operated during the preceding calendar year, and sources modified during the same period which were not previously reported. All air emissions from the facility should be estimated and reported.

(b) A source owner or operator of a Synthetic Minor Facility may request an extension of time from the Department for the filing of an annual emissions report, and the Department may grant the extension for reasonable cause.

#024 [25 Pa. Code §135.4]**Report Format**

If applicable, the emissions reports shall contain sufficient information to enable the Department to complete its emission inventory. Emissions reports shall be made by the source owner or operator in a format specified by the Department.

**SECTION C. Site Level Requirements****I. RESTRICTIONS.****Emission Restriction(s).****# 001 [25 Pa. Code §123.1]****Prohibition of certain fugitive emissions**

(a) No person may permit the emission into the outdoor atmosphere of fugitive air contaminants from a source other than the following:

- (1) Construction or demolition of buildings or structures.
- (2) Grading, paving and maintenance of roads and streets.
- (3) Use of roads and streets. Emissions from material in or on trucks, railroad cars and other vehicular equipment are not considered as emissions from use of roads and streets.
- (4) Clearing of land.
- (5) Stockpiling of materials.
- (6) Open burning operations.
- (7) Blasting in open pit mines. Emissions from drilling are not considered as emissions from blasting.
- (9) Sources and classes of sources other than those identified above, for which the permittee has obtained a determination from the Department that fugitive emissions from the source, after appropriate control, meet the following requirements:
 - (i) The emissions are of minor significance with respect to causing air pollution,
 - (ii) The emissions are not preventing or interfering with the attainment or maintenance of any ambient air quality standard.

002 [25 Pa. Code §123.2]**Fugitive particulate matter**

No person may permit fugitive particulate matter to be emitted into the outdoor atmosphere from a source specified in Condition #001(a)(1)-(7) and (9) if the emissions are visible at the point the emissions pass outside the person's property.

003 [25 Pa. Code §123.41]**Limitations**

No person may permit the emission into the outdoor atmosphere of visible air contaminants in such a manner that the opacity of the emission is either of the following:

- (1) Equal to or greater than 20% for a period or periods aggregating more than three minutes in any 1 hour,
- (2) Equal to or greater than 60% at any time.

004 [25 Pa. Code §123.42]**Exceptions**

The emission limitations of 25 Pa. Code Section 123.41 shall not apply when:

- (1) The presence of uncombined water is the only reason for failure of the emission to meet the limitations,
- (2) The emissions result from the operation of equipment used solely to train and test persons in observing the opacity of visible emissions,
- (3) The emission results from sources specified in 25 Pa. Code Section 123.1(a)(1)-(9).

005 [25 Pa. Code §127.441]**Operating permit terms and conditions.**

[Additional authority for this permit condition is derived from the permittee requesting this Synthetic Minor limitation]

**SECTION C. Site Level Requirements**

- (a) The total combined sulfur oxides (SO_x) emissions from all sources at this facility shall not equal or exceed 100 tons in any 12 consecutive month period.
- (b) The total combined carbon monoxide (CO) emissions from all sources at this facility shall not equal or exceed 100 tons in any 12 consecutive month period.

Fuel Restriction(s).**# 006 [25 Pa. Code §127.441]****Operating permit terms and conditions.**

[Additional authority for this permit condition is derived from 25 Pa. Code Sections 127.1 and 127.12 and the permittee requesting the following limitations]

(a) Reclaimed/reprocessed oil or waste oil used in Source ID P104 and reclaimed/reprocessed oil used in Source P201 shall not contain contaminants in excess of the following limitations listed below:

- (1) Arsenic - 5 ppmw
- (2) Cadmium - 2 ppmw
- (3) Chromium - 10 ppmw
- (4) Lead - 100 ppmw
- (5) Total Halides - 1,000 ppmw
- (6) Polychlorinated Biphenyls (PCBs) - Non Detectable (minimum detection limit of 2 ppmw)

(b) The sulfur content of any virgin No. 2 fuel oil, reclaimed/reprocessed oil, and/or blend of reclaimed/reprocessed/virgin/waste oil used at this facility, shall not exceed 0.5%, by weight.

(c) The heat content of the fuel oil used in Source IDs P104 and P201 shall not be less than 136,000 Btu per gallon and the flash point shall not be less than 100 degrees Fahrenheit.

(d) The permittee shall not accept for use in Source IDs P104 and P201 any shipment of reclaimed/reprocessed oil for which the arsenic, cadmium, chromium, lead, total halides, polychlorinated biphenyls (PCBs), Btu per gallon heat content, sulfur content and flash points are unknown or which fails to meet any of the limitations as specified above.

II. TESTING REQUIREMENTS.**# 007 [25 Pa. Code §127.441]****Operating permit terms and conditions.**

[Additional authority for this permit condition is derived from 25 Pa. Code Section 127.1 and 127.12]

(a) The permittee shall use the following analytical techniques and test methods in determining compliance with the fuel limitations of reclaimed/reprocessed oil or waste oil used in Source ID P104 and reclaimed/reprocessed oil used in Source ID P201:

- (1) Arsenic - EPA Method 3051, 6010, 6020, or 7000 Series
- (2) Cadmium - EPA Method 6010, 6020, or 7000 Series
- (3) Chromium - EPA Method 6010 or 7000 Series
- (4) Lead - EPA Method 6010 or 7000 Series

**SECTION C. Site Level Requirements**

(5) PCBs - EPA Method 8082 (minimum detection limit of 2 ppmw)

(6) Total Halides - EPA Method 9075, 9076, or 9077

(8) Flash Point - EPA Method 1010 or ASTM D-93-80

(10) Sulfur - ASTM D4294

(11) Ash - ASTM D482

(b) All ASTM testing methods referenced above shall be the most recent revision to the respective methods.

(c) The Department may choose to substitute any methods or techniques above to determine compliance with the fuel oil limitations. The permittee may also submit a request to the Department, for approval, if they wish to substitute any or all of the above analytical methods or techniques.

008 [25 Pa. Code §127.441]

Operating permit terms and conditions.

(a) Each load of reclaimed/reprocessed oil or blended reclaimed/reprocessed/virgin oil delivered to the facility shall be analyzed for arsenic, cadmium, chromium, lead, PCBs, total halides, and flash point and the results known at the time of delivery.

(b) A sample of each load of reclaimed/reprocessed oil or blended reclaimed/reprocessed/virgin oil delivered to the facility shall be taken at the time of delivery using a sampling technique capable of achieving a representative composite sample of the entire load. The samples are to be sealed and identified as to the date of delivery, delivery invoice number, etc.

(c) Each sample shall be retained for a minimum of two (2) years for random selection and analysis by the Department.

(d) No load of reclaimed/reprocessed oil or blended reclaimed/reprocessed/virgin oil shall be accepted for which analytical results are unavailable or for which the analytical results show non-compliance with any limitation specified in Condition #006 above for the facility.

009 [25 Pa. Code §127.441]

Operating permit terms and conditions.

(a) The permittee shall perform tests in accordance with the provisions of 25 Pa. Code Chapter 139, or provide a fuel certification report of the percent sulfur by weight of each delivery of virgin No. 2 fuel oil or lighter fuel oil.

OR

(b) The permittee shall keep records of fuel certification reports obtained yearly from the fuel oil supplier stating that the sulfur percentage for each shipment of fuel delivered to the facility during the year shall not exceed 0.5% sulfur by weight for virgin No. 2 fuel oil or lighter fuel oil.

010 [25 Pa. Code §127.441]

Operating permit terms and conditions.

(a) At least sixty (60) days prior to the performance of the stack testing if required by this permit, a test plan shall be submitted to the Department for evaluation. The plan shall contain a description of the proposed test methods and dimensioned drawings or sketches showing the test port locations.

(b) The Department shall be given at least fifteen (15) days advance notice of the scheduled dates for the performance of the stack testing required by this permit.

(c) Within sixty (60) days of the completion of the stack tests if required by this permit, two (2) copies of the test report shall be submitted to the Department. This report shall contain the results of the tests, a description of the testing and analytical procedures actually used in performance of the tests, all process and operating data collected during the tests, a copy of all raw data, and a copy of all calculations generated during data analysis.

**SECTION C. Site Level Requirements****# 011 [25 Pa. Code §139.1]****Sampling facilities.**

Upon the request of the Department, the permittee shall provide adequate sampling ports, safe sampling platforms and adequate utilities for the performance by the Department of tests on such source. The Department will set forth, in the request, the time period in which the facilities shall be provided as well as the specifications for such facilities.

012 [25 Pa. Code §139.11]**General requirements.**

(a) As specified in 25 Pa. Code Section 139.11(1), performance tests shall be conducted while the source is operating at maximum routine operating conditions or under such other conditions, within the capacity of the equipment, as may be requested by the Department.

(b) As specified in 25 Pa. Code Section 139.11(2), the Department will consider test results for approval where sufficient information is provided to verify the source conditions existing at the time of the test and where adequate data is available to show the manner in which the test was conducted. Information submitted to the Department shall include, as a minimum, all of the following:

- (1) A thorough source description, including a description of any air cleaning devices and the flue,
- (2) Process conditions, for example, the charging rate of raw material or rate of production of final product, boiler pressure, oven temperature, and other conditions, which may effect emissions from the process,
- (3) The location of sampling ports,
- (4) Effluent characteristics, including velocity, temperature, moisture content, gas density (percentage of CO, CO₂, O₂ and N₂), static and barometric pressures,
- (5) Sample collection techniques employed, including procedures used, equipment descriptions and data to verify that isokinetic sampling for particulate matter collection occurred and that acceptable test conditions were met,
- (6) Laboratory procedures and results,
- (7) Calculated results.

III. MONITORING REQUIREMENTS.**# 013 [25 Pa. Code §123.43]****Measuring techniques**

Visible emissions may be measured using either of the following:

- (1) A device approved by the Department and maintained to provide accurate opacity measurements,
- (2) Observers, trained and qualified, to measure plume opacity with the naked eye or with the aid of any devices approved by the Department.

014 [25 Pa. Code §127.441]**Operating permit terms and conditions.**

(a) The permittee shall conduct a weekly inspection of the facility during daylight hours while the facility is operating to detect visible emissions, visible fugitive emissions and malodors. Weekly inspections are necessary to determine:

- (1) The presence of visible emissions,
- (2) The presence of visible fugitive emissions,
- (3) The presence of malodors beyond the boundaries of the facility.

(b) All detected visible emissions, visible fugitive emissions or malodors that have the potential to exceed applicable limits

**SECTION C. Site Level Requirements**

shall be reported to the manager of the facility.

IV. RECORDKEEPING REQUIREMENTS.**# 015 [25 Pa. Code §127.441]****Operating permit terms and conditions.**

(a) The permittee shall keep accurate and comprehensive records of the following:

- (1) Each shipment of virgin No. 2 fuel oil, reclaimed/reprocessed oil, and/or blended reclaimed/reprocessed/virgin/waste oil received at the facility (that includes date of delivery, amount of shipment received, shipment supplier, destination of shipment).
 - (2) The test analyses of the each delivered shipment of reclaimed/reprocessed oil to verify compliance with the arsenic, cadmium, chromium, lead, PCBs, sulfur content, total halides, and flash point limitations for Source IDs P104 and P201 at the facility.
 - (3) The test analyses of the waste oil to verify compliance with the arsenic, cadmium, chromium, lead, PCBs, sulfur content, total halides, and flash point limitations for Source ID P104 at the facility.
 - (4) The test analyses or fuel oil certifications to verify the 0.5% sulfur content, by weight, of the virgin #2 fuel oil, reclaimed/reprocessed oil, and/or blended reclaimed/reprocessed/virgin/waste oil used at the facility.
 - (5) The supporting calculations, on a monthly basis, used to verify compliance with the sulfur oxides (SOx) emissions limitation for all sources at the facility in any 12 consecutive month period.
 - (6) The supporting calculations, on a monthly basis, used to verify compliance with the carbon monoxide (CO) emissions limitation for all sources at the facility in any 12 consecutive month period.
- (b) These records shall be maintained for a minimum of five (5) years and be made available to the Department upon request. Additionally, the records for items 2-4 of this conditions shall identify the specific source of all analytical data provided and describe why the analytical data accurately represents the contaminant concentrations, Btu content, and flash point of the reclaimed/reprocessed oil delivered to the facility.

016 [25 Pa. Code §127.441]**Operating permit terms and conditions.**

- (a) The permittee shall maintain a logbook of the facility's weekly inspections. The logbook shall include the name of the company representative performing the inspection, the date and time of inspections, any instances of exceedances of visible emissions limitations, visible fugitive emissions limitations and malodorous air emissions limitations, and the name of the manager informed if a potential exceedance is observed. The permittee shall also record any and all corrective action(s) taken to abate each recorded deviation to prevent future occurrences.
- (b) These records shall be retained for a minimum of five (5) years and shall be made available to the Department upon request.

017 [25 Pa. Code §135.5]**Recordkeeping**

- (a) The permittee shall maintain and make available upon request by the Department records including computerized records that may be necessary to comply with 25 Pa. Code Section 135.3 (relating to reporting). These may include records of production, fuel usage, maintenance of production or pollution control equipment or other information determined by the Department to be necessary for identification and quantification of potential and actual air contaminant emissions.
- (b) These records shall be retained for at least five (5) years and shall be made available to the Department upon request.

**SECTION C. Site Level Requirements****V. REPORTING REQUIREMENTS.****# 018 [25 Pa. Code §127.441]****Operating permit terms and conditions.**

(a) The permittee shall submit semi-annual reports to the Department on the following information:

(1) The monthly emissions of sulfur oxides (SO_x) emissions and the supporting calculations/documentation (includes total emissions, tons per year (TPY), based on a 12-month rolling total for each month in the reporting period).

(2) The monthly emissions of carbon monoxide (CO) emissions and the supporting calculations/documentation (includes total emissions, tons per year (TPY), based on a 12-month rolling total for each month in the reporting period).

(b) The semi-annual reports shall be submitted to the Department no later than March 1 (for the period January 1 through December 31) and September 1 (for the period July 1 through June 30).

019 [25 Pa. Code §127.441]**Operating permit terms and conditions.**

Upon request by the Department, the permittee shall submit all requested reports in accordance with the Department's suggested format.

020 [25 Pa. Code §127.441]**Operating permit terms and conditions.**

(a) The permittee shall report malfunctions to the Department. A malfunction is any sudden, infrequent, and not reasonably preventable failure of air pollution control equipment, process equipment, or a process to operate in a normal or usual manner. Failures that are caused in part by poor maintenance or careless operation are not malfunctions.

(b) Failures that are caused in part by poor maintenance or careless operation shall be reported as excess emissions or deviations from the operating permit requirements.

(c) When the malfunction, excess emissions or deviation from this operating permit requirements poses an imminent danger to the public health, safety, welfare, or environment shall be reported by telephone to the Department and the County Emergency Management Agency within one (1) hour after the incident. The owner or operator shall submit a written report of instances of such incidents to the Department within three (3) business days of the telephone report.

(d) Except as reported to the Department in accordance with 25 Pa. Code Chapter 139 and the Department's Continuous Source Monitoring Manual, any malfunction or excess emissions that is not subject to the notice requirements of subsection (c) of this operating permit condition shall be reported to the Department within 24 hours of discovery or the next business day. In notifying the Department, the permittee shall describe the following:

- (i) name and location of the facility;
- (ii) nature and cause of the malfunction or breakdown;
- (iii) time when the malfunction or breakdown was first observed;
- (iv) expected duration of excess emissions;
- (v) estimated rate of emissions; and
- (vi) corrective actions or preventative measures taken.

(e) The permittee shall notify the Department within 24 hours, or the next business day, when corrective measures have been accomplished.

(f) Upon the request of the Department, the permittee shall submit a full written report to the Regional Air Program Manager within 15 days of the malfunction, excess emissions or deviation from the operating permit requirements.

021 [25 Pa. Code §127.441]**Operating permit terms and conditions.**

[Additional authority for this permit condition is also derived from 25 Pa. Code Section 135.3]

(a) The permittee shall submit by March 1 of each year an Annual Air Information Management Systems (AIMS) Emissions report for the preceding calendar year. The report shall include information for all previously reported sources, new sources

**SECTION C. Site Level Requirements**

which were first operated during the preceding calendar year and sources modified during the same period which were not previously reported.

(b) The permittee may request an extension of time from the Department for the filing of an Annual Air Information Management Systems (AIMS) Emissions report, and the Department may grant the extension for reasonable cause.

VI. WORK PRACTICE REQUIREMENTS.**# 022 [25 Pa. Code §123.1]****Prohibition of certain fugitive emissions**

For any source specified in 25 Pa. Code Section 123.1 subsection(s) (a)(1)-(7) or (a)(9), the permittee shall take all reasonable actions to prevent particulate matter from becoming airborne. These actions shall include, but not be limited to, the following:

- (1) Use, where possible, of water or chemicals for control of dust in the demolition of buildings or structures, construction operations, the grading of roads or the clearing of land,
- (2) Application of asphalt, oil, or suitable chemicals on dirt roads, material stockpiles and other surfaces which may give rise to airborne dusts,
- (3) Paving and maintenance of roadways,
- (4) Prompt removal of earth or other material from paved streets onto which earth or other material has been transported by trucking or earth moving equipment, erosion by water, or other means.

023 [25 Pa. Code §127.441]**Operating permit terms and conditions.**

An operable water truck equipped with a pressurized spray bar and a pressurized spray gun or hose connection shall be kept on site and filled with water at all times during plant operation. The water truck shall be used, as needed, for the prevention and control of fugitive air contaminants emissions from haul roads, roadways, stockpiles, truck loading activities, etc. The haul roads (Source ID P101) shall be saturated to the point where the facility is in compliance with 25 Pa. Code Section 123.1.

024 [25 Pa. Code §127.441]**Operating permit terms and conditions.**

The water spray dust suppression system (ID C140) shall be operated on any and all occasions that Source IDs P102 and P103 are operated, except in those unusual instances where conditions are such that operation of the sources without the simultaneous operation of the water spray dust suppression system (C140) can take place without creating air contaminant emissions in excess of the limitations specified in 25 Pa. Code Section 123.1 and 40 CFR Part 60 Subpart OOO Sections 60.670-60.676. If, however, the water spray dust suppression system (C140) associated with the aforementioned sources is incapable of operation due to weather conditions or any other reason Source IDs P102 and P103 may not be operated at all.

025 [25 Pa. Code §127.441]**Operating permit terms and conditions.**

The water spray dust suppression system (ID C140) shall be connected to an on-demand water source capable of delivering an adequate supply of water at any time Source IDs P102 and P103 are in operation. On-demand shall be interpreted as meaning that adequate water can be provided to all spray nozzles at any time with no more effort than turning a valve. If at any time the water source cannot deliver an adequate supply of water to properly operate the water spray dust suppression system, the permittee shall immediately cease operation of Source IDs P102 and P103.

VII. ADDITIONAL REQUIREMENTS.**# 026 [25 Pa. Code §121.7]****Prohibition of air pollution.**

No person may permit air pollution as that term is defined in the act (The Air Pollution Control Act (35 P.S. §§ 4001-4015)).

**SECTION C. Site Level Requirements****# 027 [25 Pa. Code §123.31]****Limitations**

No person may permit the emission into the outdoor atmosphere of any malodorous air contaminants from any source in a manner that the malodors are detectable outside the property of the person on whose land the source is being operated.

028 [25 Pa. Code §127.441]**Operating permit terms and conditions.**

Any of the aggregate plant equipment of this facility with the exception of the air pollution control devices and rotary stone dryers, can be replaced without obtaining plan approval by the Department, provided that the replacement equipment is of equal or smaller size as defined in 40 CFR Part 60 Subpart OOO Sections 60.670-60.676, and provided that the replacement equipment is of equivalent design and function (i.e., a impact crusher may be replaced with a impact crusher, etc.). The permittee shall notify the Department, in writing, prior to the replacement.

029 [25 Pa. Code §129.14]**Open burning operations**

No person may permit the open burning of material at the facility unless in accordance with 25 Pa. Code Section 129.14.

VIII. COMPLIANCE CERTIFICATION.

No additional compliance certifications exist except as provided in other sections of this permit including Section B (relating to State Only General Requirements).

IX. COMPLIANCE SCHEDULE.

No compliance milestones exist.

**SECTION D. Source Level Requirements**

Source ID: 031

Source Name: GARAGE FURNACE

Source Capacity/Throughput:

0.400 MMBTU/HR

2.850 Gal/HR

#2 FUEL OIL

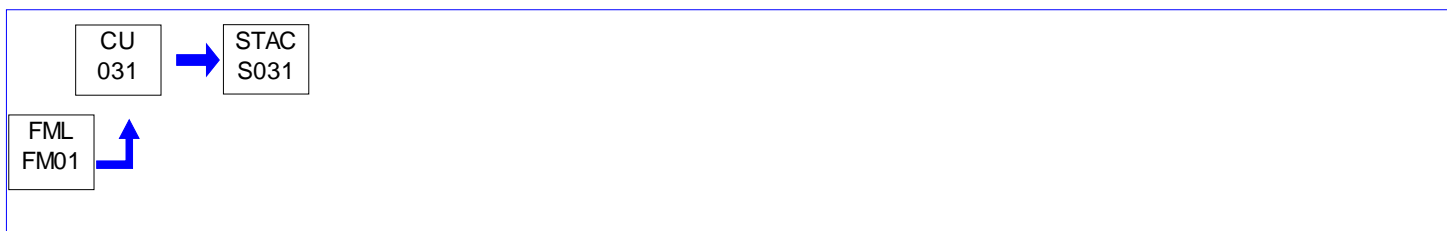
**I. RESTRICTIONS.****Emission Restriction(s).**

001 [25 Pa. Code §123.22]

Combustion units

No person may permit the emission of sulfur oxides (SO_x), expressed as SO₂ into the outdoor atmosphere from Source ID 031 in excess of the rate of 4 pounds per million Btu of heat input over any 1-hour period.

Fuel Restriction(s).

002 [25 Pa. Code §127.441]

Operating permit terms and conditions.

(a) The permittee shall only use virgin No. 2 fuel oil as fuel for Source ID 031.

(b) The sulfur content of any No. 2 virgin fuel oil fired in Source ID 031 shall not exceed 0.05%, by weight.

(c) Additionally, the permittee shall not fire any reclaimed/reprocessed oil or waste oil in Source ID 031 under any circumstance.

II. TESTING REQUIREMENTS.

No additional testing requirements exist except as provided in other sections of this permit including Section B (State Only General Requirements).

III. MONITORING REQUIREMENTS.

No additional monitoring requirements exist except as provided in other sections of this permit including Section B (State Only General Requirements).

IV. RECORDKEEPING REQUIREMENTS.

No additional record keeping requirements exist except as provided in other sections of this permit including Section B (State Only General Requirements).

V. REPORTING REQUIREMENTS.

No additional reporting requirements exist except as provided in other sections of this permit including Section B (State Only General Requirements).

**SECTION D. Source Level Requirements****VI. WORK PRACTICE REQUIREMENTS.**

No additional work practice requirements exist except as provided in other sections of this permit including Section B (State Only General Requirements).

VII. ADDITIONAL REQUIREMENTS.

003 [25 Pa. Code §127.441]

Operating permit terms and conditions.

Source ID 031 is a garage furnace, No. 2 fuel oil fired, Burnham Model FDO/15, 0.40 MMBtu/hr rated heat input.

**SECTION D. Source Level Requirements**

Source ID: P101

Source Name: HAUL ROADS

Source Capacity/Throughput:

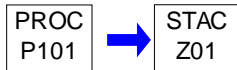
**I. RESTRICTIONS.**

No additional requirements exist except as provided in other sections of this permit including Section B (State Only General Requirements).

II. TESTING REQUIREMENTS.

No additional testing requirements exist except as provided in other sections of this permit including Section B (State Only General Requirements).

III. MONITORING REQUIREMENTS.

No additional monitoring requirements exist except as provided in other sections of this permit including Section B (State Only General Requirements).

IV. RECORDKEEPING REQUIREMENTS.

No additional record keeping requirements exist except as provided in other sections of this permit including Section B (State Only General Requirements).

V. REPORTING REQUIREMENTS.

No additional reporting requirements exist except as provided in other sections of this permit including Section B (State Only General Requirements).

VI. WORK PRACTICE REQUIREMENTS.**# 001 [25 Pa. Code §127.441]****Operating permit terms and conditions.**

An operable water truck equipped with a pressurized spray bar and a pressurized spray gun or hose connection shall be kept on site and filled with water at all times during plant operation. The water truck shall be used, as needed, for the prevention and control of fugitive air contaminant emissions from haul roads, roadways, stockpiles, truck loading activities, etc. The haul roads (Source ID P101) shall be saturated to the point where the facility is in compliance with 25 Pa. Code Section 123.1.

VII. ADDITIONAL REQUIREMENTS.**# 002 [25 Pa. Code §127.441]****Operating permit terms and conditions.**

Source ID P101 consists of unpaved haul roads.

**SECTION D. Source Level Requirements**

Source ID: P102

Source Name: PRIMARY CRUSHING AREA

Source Capacity/Throughput: 200.000 Tons/HR AGGREGATES

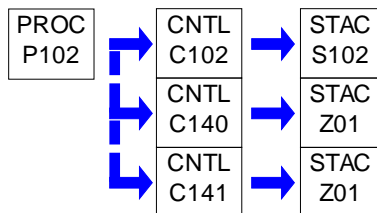
**I. RESTRICTIONS.****Emission Restriction(s).****# 001 [25 Pa. Code §127.441]****Operating permit terms and conditions.**

[Compliance with the requirement specified in this streamlined permit condition assures compliance with the provision in 25 Pa. Code Section 123.13]

The particulate matter emissions from the primary crushing dust collector (ID C102) controlling the emissions from Source ID P102 shall not exceed 0.0218 grains per standard dry cubic foot.

002 [40 CFR Part 60 Standards of Performance for New Stationary Sources §40 CFR 60.672]**Subpart OOO - Standards of Performance for Nonmetallic Mineral Processing Plants
Standard for particulate matter.**

The permittee shall comply with all applicable requirements specified in 40 CFR Part 60 Subpart OOO Section 60.672 for Source ID P102.

II. TESTING REQUIREMENTS.**# 003 [25 Pa. Code §127.441]****Operating permit terms and conditions.**

(a) The permittee shall comply with all applicable testing requirements specified in 40 CFR Part 60 Subpart OOO Section 60.675 for Source ID P102.

(b) However, the permittee need not perform any opacity testing or stack testing unless specifically requested to do so by the Department or the U.S. Environmental Protection Agency.

III. MONITORING REQUIREMENTS.**# 004 [25 Pa. Code §127.441]****Operating permit terms and conditions.**

[Additional authority for this permit condition is derived from 25 Pa. Code Sections 127.1 and 127.12]

The primary crushing dust collector (ID C102) shall be equipped with instrumentation to monitor the pressure drop across the fabric collector on a continuous basis.

IV. RECORDKEEPING REQUIREMENTS.**# 005 [25 Pa. Code §127.441]****Operating permit terms and conditions.**

(a) The permittee shall keep records of the pressure drop across the primary crushing dust collector (ID C102) associated with Source ID P102 at least once per day.

(b) These records shall be retained for a minimum of five (5) years and be made available to the Department upon request.

**SECTION D. Source Level Requirements****# 006 [40 CFR Part 60 Standards of Performance for New Stationary Sources §40 CFR 60.676]****Subpart 000 - Standards of Performance for Nonmetallic Mineral Processing Plants****Reporting and recordkeeping.**

The permittee shall comply with all applicable recordkeeping requirements specified in 40 CFR Part 60 Subpart 000 Section 60.676 for Source ID P102.

V. REPORTING REQUIREMENTS.**# 007 [40 CFR Part 60 Standards of Performance for New Stationary Sources §40 CFR 60.4]****Subpart A - General Provisions****Address.**

The submission of all requests, reports, applications, submittals and other communications required by 40 CFR Part 60 Subpart 000 Sections 60.670 through 60.676 shall be submitted to both the U. S. Environmental Protection Agency and the Department. The Environmental Protection Agency copies may be sent to:

Director
Air Protection Division (3AP00)
U. S. EPA, Region III
1650 Arch Street
Philadelphia, PA 19103-2029

and

The Pennsylvania Department of Environmental Protection
Air Quality Program Manager
208 W. Third Street, Suite 101
Williamsport, PA 17701-6448

VI. WORK PRACTICE REQUIREMENTS.**# 008 [25 Pa. Code §127.441]****Operating permit terms and conditions.**

The permittee shall not operate Source ID P102 without the simultaneous operation of the primary crushing dust collector (ID C102).

009 [25 Pa. Code §127.441]**Operating permit terms and conditions.**

[Additional authority for this permit condition is derived from 25 Pa. Code Sections 127.1 and 127.12]

The permittee shall keep on hand a sufficient quantity of spare fabric collector bags for the primary crushing dust collector (ID C102), in order to be able to immediately replace any bags requiring replacement due to deterioration.

010 [25 Pa. Code §127.441]**Operating permit terms and conditions.**

The handling and storage of the material collected in the primary crushing dust collector (ID C102) associated with Source ID P102 shall not at any time result in the emission of fugitive air contaminants in excess of the limitations specified in 25 Pa. Code Section 123.1.

011 [25 Pa. Code §127.441]**Operating permit terms and conditions.**

The surfactant foam dust suppression system (ID C141) shall be connected to an on-demand water source capable of delivering an adequate supply of water at any time Source ID P102 is in operation. On-demand shall be interpreted as meaning that adequate water can be provided to the chemical dust suppression system at any time with no more effort than turning a valve. If at any time the water source cannot deliver an adequate supply of water to properly operate the surfactant foam dust suppression system, the permittee shall immediately cease operation of Source ID P102.

**SECTION D. Source Level Requirements****# 012 [25 Pa. Code §127.441]****Operating permit terms and conditions.**

The surfactant foam dust suppression system (ID C141) shall be operated on any and all occasions that the impact and/or cone crushers associated with Source ID P102 are operated, except in those unusual instances where conditions are such that operation of the sources without the simultaneous operation of the surfactant foam dust suppression system (C141) can take place without creating air contaminant emissions in excess of the limitations specified in 25 Pa. Code Sections 123.1 and 40 CFR Part 60 Subpart OOO Sections 60.670-60.676. If, however, the surfactant foam dust suppression system (C141) is incapable of operation due to weather conditions or any other reason Source ID P102 may not be operated at all.

VII. ADDITIONAL REQUIREMENTS.**# 013 [25 Pa. Code §127.441]****Operating permit terms and conditions.**

(a) The particulate matter emissions from the impact crusher and cone crusher associated with Source ID P102 shall be controlled by the primary crushing dust collector (ID C102) and the surfactant foam dust suppression system (ID C141) while the impact crusher and cone crusher of Source ID P102 are in operation.

(b) The particulate matter emissions from Source ID P102 shall be controlled by ID C102 and the water spray dust suppression system (ID C140) while Source ID P102 is in operation.

014 [25 Pa. Code §127.441]**Operating permit terms and conditions.**

(a) Source ID P102 is the Primary Crushing System which consists of the following:

- One (1) Dump Hopper, 50 Ton
- One (1) 4" Grizzly Screen, Universal, 350 TPH
- Four (4) Bins consisting of #4 Ballst-30 Ton, Oversize-37 Ton, 2B-45 Ton, and #2-20 Ton
- One (1) Screen, Bondad 3' x 6', 200 TPH
- One (1) Screener, Triple Deck, Allis Chalmer 4'x12', 175 TPH
- One (1) Conveyor, 20"x62', 200 TPH
- One (1) Conveyor, 20" x 58', 200 TPH
- Three (3) Bins, 2 ½'- 30 Ton, Anti-Skid - 20 Ton, and 2A or 2RC - 45 Ton
- One (1) Primary Impact Crusher, Cedar Rapids, Model 42x25, 375 TPH
- One (1) Conveyor Hopper
- One (1) Conveyor, 30" wide x 94' , Primary Crusher Discharge to Triple Deck Inlet, 375 TPH
- One (1) Screener, Triple Deck, Allis Chalmer Model 5x15, 375 TPH
- One (1) Cone Crusher, Svedala, 125 TPH
- One (1) Belt Feeder, 26" x 11' , #72A
- One (1) Bucket Elevator, 16" x 35', 100 TPH
- One (1) Screener, Triple Deck, Dister, Model 4x8, 125 TPH
- Four (4) Conveyors, #69,70,71,76
- One (1) Bin, #2, 20 Ton
- One (1) Mogensen Screen, Old, Model 1556, 40 TPH
- One (1) Mogensen Screen, New, Model 1556, 40 TPH
- Five (5) Bins, Manufactured Sand, 1B, #9 & Anti-Skid, Manufactured Sand, and Limestone Fines

(b) ID C102 is a reverse jet fabric filter, Aeropulse Model M-504-10T-Y-1976, 35,000 CFM

(c) ID C140 is a water spray dust suppression system.

(d) ID C141 is a surfactant foam dust suppression system, Martin Marietta Dust Buster

015 [40 CFR Part 60 Standards of Performance for New Stationary Sources §40 CFR 60.670]**Subpart OOO - Standards of Performance for Nonmetallic Mineral Processing Plants****Applicability and designation of affected facility.**

**SECTION D. Source Level Requirements**

(a) The following equipment of Source ID P102 is subject to 40 CFR Part 60 Subpart 000:

- One (1) Screener, Triple Deck, Allis Chalmer 4'x12', 175 TPH
- One (1) Conveyor, 20"x 62', 200 TPH
- Three (3) Bins, 2-1/2"- 30 Ton, Anti-Skid - 20 Ton, and 2A or 2RC - 45 Ton
- One (1) Cone Crusher, Svedala, Model H-3000, 125 TPH
- One (1) Belt Feeder, 26" x 11', #72A
- One (1) Mogensen Screen, Old, Model 1556, 40 TPH
- One (1) Mogensen Screen, New, Model 1556, 40 TPH
- Five (5) Bins, Manufactured Sand, 1B, #9 & Anti-Skid, Manufactured Sand, and Limestone Fines

(b) The permittee shall comply with all applicable requirements specified in 40 CFR Section 60.670 through 60.676.

**SECTION D. Source Level Requirements**

Source ID: P103

Source Name: SECONDARY CRUSHING AREA

Source Capacity/Throughput: 200.000 Tons/HR AGGREGATES

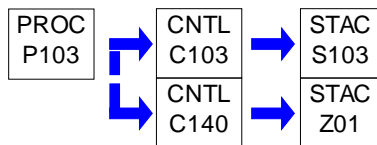
**I. RESTRICTIONS.****Emission Restriction(s).**

001 [25 Pa. Code §127.441]

Operating permit terms and conditions.

[Additional authority for this permit condition is derived from 25 Pa. Code Sections 127.1 and 127.12]

{Compliance with the requirement specified in this streamlined permit condition assures compliance with the provision in 25 Pa. Code Section 123.13}

The particulate matter emissions from the secondary crushing dust collector (ID C103) controlling the emissions from Source ID P103 shall not exceed 0.0218 grains per standard dry cubic foot.

002 [40 CFR Part 60 Standards of Performance for New Stationary Sources §40 CFR 60.672]

**Subpart OOO - Standards of Performance for Nonmetallic Mineral Processing Plants
Standard for particulate matter.**

The permittee shall comply with all applicable requirements specified in 40 CFR Part 60 Subpart OOO Section 60.672 for Source ID P103.

II. TESTING REQUIREMENTS.

003 [25 Pa. Code §127.441]

Operating permit terms and conditions.

(a) The permittee shall comply with all applicable testing requirements specified in 40 CFR Part 60 Subpart OOO Section 60.675 for Source ID P103.

(b) However, the permittee need not perform any opacity testing or stack testing unless specifically requested to do so by the Department or the U.S. Environmental Protection Agency.

III. MONITORING REQUIREMENTS.

004 [25 Pa. Code §127.441]

Operating permit terms and conditions.

[Additional authority for this permit condition is derived from 25 Pa. Code Sections 127.1 and 127.12]

The secondary crushing dust collector (ID C103) shall be equipped with instrumentation to monitor the pressure drop across the fabric collector on a continuous basis.

IV. RECORDKEEPING REQUIREMENTS.

005 [25 Pa. Code §127.441]

Operating permit terms and conditions.

(a) The permittee shall keep records of the pressure drop across the secondary crushing dust collector (ID C103) at least once per day.

(b) These records shall be retained for a minimum of five (5) years and be made available to the Department upon request.

**SECTION D. Source Level Requirements****# 006 [40 CFR Part 60 Standards of Performance for New Stationary Sources §40 CFR 60.676]****Subpart 000 - Standards of Performance for Nonmetallic Mineral Processing Plants****Reporting and recordkeeping.**

The permittee shall comply with all applicable recordkeeping requirements specified in 40 CFR Part 60 Subpart 000 Section 60.676 for Source ID P103.

V. REPORTING REQUIREMENTS.**# 007 [40 CFR Part 60 Standards of Performance for New Stationary Sources §40 CFR 60.4]****Subpart A - General Provisions****Address.**

The submission of all requests, reports, applications, submittals and other communications required by 40 CFR Part 60 Subpart 000 Sections 60.670 through 60.676 shall be submitted to both the U. S. Environmental Protection Agency and the Department. The Environmental Protection Agency copies may be sent to:

Director
Air Protection Division (3AP00)
U. S. EPA, Region III
1650 Arch Street
Philadelphia, PA 19103-2029

and

The Pennsylvania Department of Environmental Protection
Air Quality Program Manager
208 W. Third Street, Suite 101
Williamsport, PA 17701-6448

VI. WORK PRACTICE REQUIREMENTS.**# 008 [25 Pa. Code §127.441]****Operating permit terms and conditions.**

The permittee shall not operate Source ID P103 without the simultaneous operation of the secondary crushing dust collector (ID C103).

009 [25 Pa. Code §127.441]**Operating permit terms and conditions.**

[Additional authority for this permit condition is derived from 25 Pa. Code Sections 127.1 and 127.12]

The permittee shall keep on hand a sufficient quantity of spare fabric collector bags for the secondary crushing dust collector (ID C103), in order to be able to immediately replace any bags requiring replacement due to deterioration.

010 [25 Pa. Code §127.441]**Operating permit terms and conditions.**

The handling and storage of the material collected in the secondary crushing dust collector (ID C103) associated with Source ID P103 shall not at any time result in the emission of fugitive air contaminants in excess of the limitations specified in 25 Pa. Code Section 123.1.

VII. ADDITIONAL REQUIREMENTS.**# 011 [25 Pa. Code §127.441]****Operating permit terms and conditions.**

(a) Source ID P103 is the Secondary Crushing System consisting of the following:

- One (1) Cage Mill, Frog Switch, 42", 200 TPH
- One (1) Triple Deck Screen, Seco, Model 5x16, 200 TPH

**SECTION D. Source Level Requirements**

- One (1) Single Deck Screen, Simplicity, Model NUZ65, 40 TPH- Three (3) Bins, Sand, 1B, and 2B
- One (1) 8'x12' Hopper, 20 Ton- One (1) Feeder, FMC Syntron Model FH228, 42" x 18", 100 TPH
- One (1) Conveyor, LB Smith, 24" x 156', 200 TPH
- One (1) Conveyor, LB Smith, 24" x 100', 100 TPH
- One (1) Conveyor, LB Smith, 30" x 42', 100 TPH
- One (1) Conveyor, LB Smith, 24" x 91', 100 TPH
- One (1) Conveyor, LB Smith, 24" x 70', 100 TPH
- One (1) Conveyor, LB Smith, 24" x 62', 100 TPH
- One (1) Conveyor, LB Smith, 24" x 82', 100 TPH
- Two (2) Conveyors, LB Smith, 24" x 40', 100 TPH
- One (1) Pneumatic Conveying System which discharges material from the secondary crushing dust collector (ID C103) to the Dust Silo (Source ID P107) and consists of a Rotary Lobe Blower - Sutorbilt Model Gale DPA, Premier Pneumatic Rotary Air Lock Model 10x10

(b) ID C103 is a fabric collector, Amerex Industries, Model RP-12-210, 20,000 CFM

(c) ID C140 is a water spray dust suppression system.

012 [25 Pa. Code §127.441]

Operating permit terms and conditions.

The particulate matter emissions from Source ID P103 shall be controlled by the secondary crushing dust collector (ID C103) and water spray dust suppression system (ID C140).

013 [40 CFR Part 60 Standards of Performance for New Stationary Sources §40 CFR 60.670]

Subpart 000 - Standards of Performance for Nonmetallic Mineral Processing Plants

Applicability and designation of affected facility.

(a) The following equipment of Source ID P103 is subject to 40 CFR Part 60 Subpart 000:

- One (1) Cage Mill, Frog Switch, 42", 200 TPH
- One (1) Triple Deck Screen, Seco, Model 5x16, 200 TPH
- One (1) Single Deck Screen, Simplicity, Model NUZ65, 40 TPH
- One (1) Feeder, FMC Syntron Model FH228, 42" x 18", 100 TPH
- One (1) Conveyor, LB Smith, 24" x 156', 200 TPH
- One (1) Conveyor, LB Smith, 24" x 100', 100 TPH
- One (1) Conveyor, LB Smith, 30" x 42', 100 TPH
- One (1) Conveyor, LB Smith, 24" x 91', 100 TPH
- One (1) Conveyor, LB Smith, 24" x 70', 100 TPH
- One (1) Conveyor, LB Smith, 24" x 62', 100 TPH
- One (1) Conveyor, LB Smith, 24" x 82', 100 TPH
- Two (2) Conveyors, LB Smith, 24" x 40', 100 TPH

(b) The permittee shall comply with all applicable requirements specified in 40 CFR Sections 60.670 through 60.676.

**SECTION D. Source Level Requirements**

Source ID: P104

Source Name: PULVERIZED LIMESTONE DRYING SYSTEM

Source Capacity/Throughput: 100.000 Tons/HR AGGREGATES

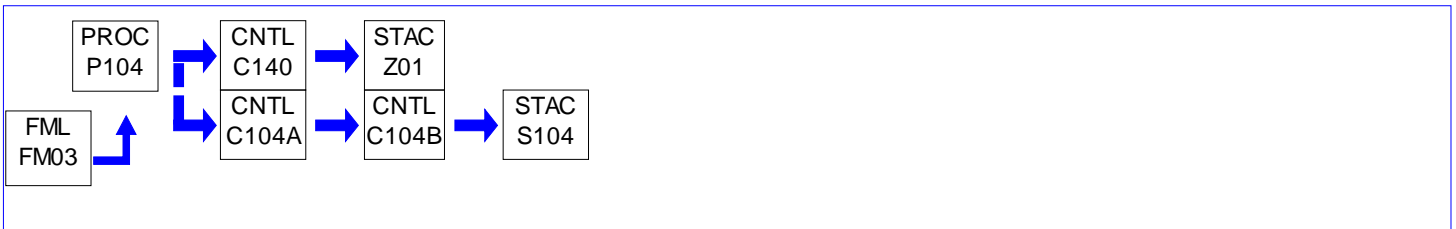
**I. RESTRICTIONS.****Emission Restriction(s).****# 001 [25 Pa. Code §123.13]****Processes**

The permittee shall not emit into the outdoor atmosphere of particulate matter, from the exhaust of the pulverized limestone drying dust collector (ID C104B) associated with Source ID P104, in a manner that the concentration of particulate matter in the effluent gas exceeds 0.04 grains per dry standard cubic foot.

002 [25 Pa. Code §123.21]**General**

[Compliance with the requirement specified in this streamlined permit condition assures compliance with the provision in 40 CFR 52.2020(c)]

No person may permit the emission of sulfur oxides expressed as SO₂, into the outdoor atmosphere from the Madison rotary stone dryer of Source ID P104 in a manner that the concentration of the sulfur oxides in the effluent gas exceeds 500 parts per million, by volume, dry basis.

003 [40 CFR Part 60 Standards of Performance for New Stationary Sources §40 CFR 60.672]**Subpart 000 - Standards of Performance for Nonmetallic Mineral Processing Plants****Standard for particulate matter.**

The permittee shall comply with all applicable requirements as specified in 40 CFR Part 60 Subpart 000 Section 60.672 for Source ID P104.

Fuel Restriction(s).**# 004 [25 Pa. Code §127.441]****Operating permit terms and conditions.**

[Additional authority for this permit condition is derived from 25 Pa. Code Section 127.1 and 127.12]

(a) Reclaimed/reprocessed oil and waste oil used in Source ID P104 shall not contain contaminants in excess of the following limitations listed below:

(1) Arsenic - 5 ppmw

(2) Cadmium - 2 ppmw

(3) Chromium - 10 ppmw

(4) Lead - 100 ppmw

(5) Total Halides - 1,000 ppmw

(6) Polychlorinated Biphenyls (PCBs) - Non Detectable (minimum detection limit of 2 ppmw)

**SECTION D. Source Level Requirements**

(b) The sulfur content of any virgin No. 2 fuel oil, reclaimed/reprocessed oil, and/or blend of reclaimed/reprocessed/virgin/waste oil fired in the rotary stone dryer burner of Source ID P104, shall not exceed 0.5%, by weight.

(c) The heat content of the reclaimed/reprocessed oil and/or blended reclaimed/reprocessed/virgin/waste oil used in Source ID P104 shall not be less than 136,000 Btu per gallon and the flash point shall not be less than 100 degrees Fahrenheit.

(d) The permittee shall not accept for use in Source ID P104 any shipment of reclaimed/reprocessed oil for which the arsenic, cadmium, chromium, lead, total halides, polychlorinated biphenyls (PCBs), Btu per gallon heat content, sulfur content and flash points are unknown or which fails to meet any of the limitation as specified above.

005 [25 Pa. Code §127.441]**Operating permit terms and conditions.**

(a) The permittee shall only use gas (natural or LP), virgin No. 2 fuel oil, reclaimed/reprocessed oil, blended reclaimed/reprocessed/virgin/waste oil as fuel for the Madison rotary stone dryer burner of Source ID P104.

(b) Additionally, Safety Kleen HTS distillate shall not be used as fuel for the Madison rotary stone dryer burner of Source ID P104

006 [25 Pa. Code §127.441]**Operating permit terms and conditions.**

(a) The waste oil shall only be collected from the permittee's vehicles and outside sources personally known to the permittee.

(b) The permittee shall not burn more than 3,000 gallons of waste oil in any 12 consecutive month period in the Madison rotary stone dryer burner of Source ID P104. Additionally, the permittee shall notify the Department prior to use of any waste oil in Source ID P104.

(c) The waste oil shall be blended and analyzed for fuel oil contaminants prior to blending with virgin No. 2 fuel oil, reclaimed/reprocessed oil, or a blend of reclaimed/reprocessed/virgin oil prior to use, and the ratio shall not be greater than 700 gallons of waste oil to 7,000 gallons of the other oil.

(d) The permittee shall not place into the waste oil tank any substance which is not oil.

Throughput Restriction(s).**# 007 [25 Pa. Code §127.441]****Operating permit terms and conditions.**

[Additional authority for this permit condition is derived from the permittee requesting this Synthetic Minor restriction]

The permittee shall not burn more than 656,000 gallons of virgin No. 2 fuel oil, reclaimed/reprocessed oil, or a blend of reclaimed/reprocessed/virgin/waste oil, of which the waste oil shall not exceed more than 3,000 gallons, in the rotary stone dryer burner of Source ID P104 in any 12 consecutive month period.

II. TESTING REQUIREMENTS.**# 008 [25 Pa. Code §127.441]****Operating permit terms and conditions.**

(a) The permittee shall comply with all applicable requirements specified in 40 CFR Part 60 Subpart OOO Section 60.675 for Source ID P104.

(b) However, the permittee need not perform any opacity testing or stack testing unless specifically requested to do so by the Department or the U.S. Environmental Protection Agency.

**SECTION D. Source Level Requirements****III. MONITORING REQUIREMENTS.****# 009 [25 Pa. Code §127.441]****Operating permit terms and conditions.**

[Additional authority for this permit condition is derived from 25 Pa. Code Sections 127.1 and 127.12]

The pulverized limestone drying dust collector (ID C104B) shall be equipped with instrumentation to monitor the pressure drop across the fabric collector filter bags on a continuous basis.

IV. RECORDKEEPING REQUIREMENTS.**# 010 [25 Pa. Code §127.441]****Operating permit terms and conditions.**

(a) The permittee shall keep records of the following for Source ID P104:

(1) The amount of virgin No. 2 fuel oil, reclaimed/reprocessed oil, and/or a blend of reclaimed/reprocessed/No. 2 virgin/waste fuel oil fired each month in the Madison rotary stone dryer burner to verify compliance with the fuel oil throughput limitation in any 12 consecutive month period.

(2) The amount of gas (natural or LP) fired each month in the Madison rotary stone dryer burner.

(3) The amount of waste oil that is blended with virgin, and/or a blend of reclaimed/reprocessed/virgin oil each month to be fired in the Madison rotary stone dryer burner of Source ID P104 to verify compliance with the waste oil throughput limitation in 12 consecutive month period.

(4) The pressure drop across the pulverized limestone drying dust collector (ID C104B) at least once per day.

(5) The analytical testing report used to verify compliance with the waste oil contaminant concentration limitations.

(b) These records shall be retained for a minimum of five (5) years and be made available to the Department upon request.

011 [40 CFR Part 60 Standards of Performance for New Stationary Sources §40 CFR 60.676]**Subpart 000 - Standards of Performance for Nonmetallic Mineral Processing Plants****Reporting and recordkeeping.**

The permittee shall comply with all applicable recordkeeping requirements as specified in 40 CFR Part 60 Subpart 000 Section 60.676 for Source ID P105.

V. REPORTING REQUIREMENTS.**# 012 [25 Pa. Code §127.441]****Operating permit terms and conditions.**

(a) The permittee shall submit annual reports to the Department on the following:

(1) The 12 month rolling total of the amount of virgin No. 2 fuel oil, reclaimed/reprocessed oil, and/or a blend of reclaimed/reprocessed/No. 2 virgin/waste fuel oil fired in the Madison rotary stone dryer burner of Source ID P104 for each month.

(2) The 12 month rolling total of the amount of waste oil fired in Madison rotary dryer burner of Source ID P104 for each month.

(b) The annual report shall be submitted to the Department no later than March 1 (for the reporting months of January through December of the previous year) for the 12 consecutive month period.

013 [40 CFR Part 60 Standards of Performance for New Stationary Sources §40 CFR 60.4]**Subpart A - General Provisions****Address.**

The submission of all requests, reports, applications, submittals and other communications required by 40 CFR Part 60 Subpart 000 Sections 60.670 through 60.676 shall be submitted to both the U. S. Environmental Protection Agency and the

**SECTION D. Source Level Requirements**

Department. The Environmental Protection Agency copies may be sent to:

Director
Air Protection Division (3AP00)
U. S. EPA, Region III
1650 Arch Street
Philadelphia, PA 19103-2029

and

The Pennsylvania Department of Environmental Protection
Air Quality Program Manager
208 W. Third Street, Suite 101
Williamsport, PA 17701-6448

VI. WORK PRACTICE REQUIREMENTS.

014 [25 Pa. Code §127.441]

Operating permit terms and conditions.

The permittee shall not operate Source ID P104 without the simultaneous operation of the cyclone separator and pulverized limestone drying dust collector (IDs C104A and C104B, respectively).

015 [25 Pa. Code §127.441]

Operating permit terms and conditions.

[Additional authority for this permit condition is derived from 25 Pa. Code Sections 127.1 and 127.12]

The permittee shall keep on hand a sufficient quantity of spare fabric collector bags for the pulverized limestone drying dust collector ID C104B, in order to be able to immediately replace any bags requiring replacement due to deterioration.

016 [25 Pa. Code §127.441]

Operating permit terms and conditions.

The handling and storage of the material collected in the pulverized limestone drying dust collector ID C104B shall not at any time result in the emission of fugitive air contaminants in excess of the limitations specified in 25 Pa. Code Section 123.1.

VII. ADDITIONAL REQUIREMENTS.

017 [25 Pa. Code §127.441]

Operating permit terms and conditions.

(a) The particulate matter emissions from Source ID P104 shall be controlled by the cyclone separator and pulverized limestone drying dust collector (IDs C104A and C104B, respectively) while Source ID P104 is in operation.

(b) Source ID P104 is the Pulverized Limestone Drying System which consists of the following:

- Three (3) Raw Stock Piles, 5,000 Ton each
- One (1) Compartment Hopper, 10'x25'
- One (1) Vibrating Feeder, FMC, 100 TPH
- One (1) Belt Conveyor, 24"x 29', 100 TPH
- One (1) Belt Conveyor, 24"x 65', 100 TPH, Rotary Dryer Inlet
- One (1) Reclaimed/Reprocessed/virgin/waste oil-fired and gas-fired (natural or LP) Rotary Stone Dryer, Madison, Model 345, 100 TPH with integral Hauck Burner, Model SJPO-1150E-011-06-12-0-00, 27.9 MMBTU/hr rated Heat Input
- One (1) Belt Conveyor, 24" x 33', 100 TPH (Rotary Dryer Outlet)
- One (1) Belt Conveyor, 24" x 21.8', 100 TPH
- One (1) Bucket Elevator, Link Belt, Model #82727-004, 100 TPH
- Three (3) Stone Bins, 100 Tons Capacity
- One (1) Screw Conveyor, 9" x 25', 2 TPH, Dust Collector Outlet
- One (1) Bucket Elevator, Model 18' x 10.5' (S/N 82x41)

**SECTION D. Source Level Requirements**

- One (1) Blade Diverter Valve, MAC Blade-Line

(b) ID C104A is a cyclone separator, Fisher-Klosterman, Inc., Model XQ-340-7

(c) ID C104B is a fabric collector, Eastern Control Systems Model 315-10, 27000 CFM

018 [40 CFR Part 60 Standards of Performance for New Stationary Sources §40 CFR 60.670]

Subpart 000 - Standards of Performance for Nonmetallic Mineral Processing Plants

Applicability and designation of affected facility.

The following equipment of Source ID P104 is subject to 40 CFR Part 60 Subpart 000:

- One (1) Compartment Hopper, 10'x25'
- One (1) Vibrating Feeders, FMC, 100 TPH
- One (1) Belt Conveyor, 24"x 29', 100 TPH
- One (1) Belt Conveyor, 24"x 65', 100 TPH, Rotary Dryer Inlet
- One (1) Belt Conveyor, 24" x 33', 100 TPH (Rotary Dryer Outlet)
- One (1) Belt Conveyor, 24" x 21.8', 1000 TPH
- One (1) Bucket Elevator, Link Belt, Model #82727-004, 100 TPH
- One (1) Screw Conveyor, 9" x 25', 2 TPH, Dust Collector Outlet
- One (1) Stone Bin, 100 Ton Capacity

**SECTION D. Source Level Requirements**

Source ID: P105

Source Name: LIMESTONE PULVERIZING AND STORAGE SYSTEM

Source Capacity/Throughput: 100.000 Tons/HR AGGREGATES

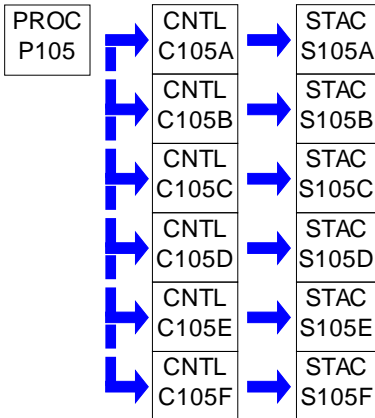
**I. RESTRICTIONS.****Emission Restriction(s).****# 001 [25 Pa. Code §127.441]****Operating permit terms and conditions.**

[Additional authority for this permit condition is derived from 25 Pa. Code Section 127.1 and 127.12]

{Compliance with the requirement specified in this streamlined permit condition assures compliance with provision in 25 Pa. Code Section 123.13 and 40 CFR Part 60 Subpart OOO Section 60.672}

The particulate matter emissions from the dust silo fabric collector (ID C105E) controlling the emissions from Silo #8 of Source ID P105 shall not exceed 0.02 grains per dry standard cubic foot.

002 [40 CFR Part 60 Standards of Performance for New Stationary Sources §40 CFR 60.672]**Subpart OOO - Standards of Performance for Nonmetallic Mineral Processing Plants
Standard for particulate matter.**

[Compliance with the requirement specified in this streamlined permit condition assures compliance with provision in 25 Pa. Code Section 123.13]

(a) The particulate matter emissions from the fabric collectors (ID C105 A through D and F) controlling the emissions from several sources of Source ID P105 shall not exceed 0.022 grains per dry standard cubic foot.

(b) The permittee shall comply with all applicable particulate matter requirements as specified in 40 CFR Part 60 Subpart OOO Section 60.672 for Source ID P105.

Throughput Restriction(s).**# 003 [25 Pa. Code §127.441]****Operating permit terms and conditions.**

The operation of Source P105 shall not exceed 6,000 hours in any 12 consecutive month period.

The above limitation has been established at the request of the permittee.

**SECTION D. Source Level Requirements****II. TESTING REQUIREMENTS.****# 004 [25 Pa. Code §127.441]****Operating permit terms and conditions.**

(a) The permittee shall comply with all applicable requirements as specified in 40 CFR Part 60 Subpart OOO Section 60.675 for Source ID P105.

(b) However, the permittee need not perform any opacity testing or stack testing unless specifically requested to do so by the Department or the U.S. Environmental Protection Agency.

III. MONITORING REQUIREMENTS.**# 005 [25 Pa. Code §127.441]****Operating permit terms and conditions.**

[Additional authority for this permit condition is derived from 25 Pa. Code Sections 127.1 and 127.12]

All fabric collectors (IDs C105A through C105F) that control particulate matter emissions from Source ID P105 shall be equipped with instrumentation to monitor the pressure drop across the fabric collector on a continuous basis.

IV. RECORDKEEPING REQUIREMENTS.**# 006 [25 Pa. Code §127.441]****Operating permit terms and conditions.**

(a) The permittee shall keep records of the pressure drop across all fabric collectors (IDs C105A through C105F) that control particulate matter emissions from Source ID P105 at least once per week.

(b) These records shall be kept for a minimum of five (5) years and be made available to the Department upon request.

007 [25 Pa. Code §127.441]**Operating permit terms and conditions.**

The permittee shall maintain accurate and comprehensive records of the number of hours that Source P105 is operated each month. These records shall be used to demonstrate compliance with the 6,000 hours in any 12 consecutive month period limitation specified herein for Source P105. All records generated pursuant to this condition shall be retained for a minimum of five (5) years and shall be made available to the Department upon request.

008 [40 CFR Part 60 Standards of Performance for New Stationary Sources §40 CFR 60.676]**Subpart OOO - Standards of Performance for Nonmetallic Mineral Processing Plants****Reporting and recordkeeping.**

The permittee shall comply with all applicable recordkeeping requirements specified in 40 CFR Part 60 Subpart OOO Section 60.676 for Source ID P105.

V. REPORTING REQUIREMENTS.**# 009 [40 CFR Part 60 Standards of Performance for New Stationary Sources §40 CFR 60.4]****Subpart A - General Provisions****Address.**

The submission of all requests, reports, applications, submittals and other communications required by 40 CFR Part 60 Subpart OOO Sections 60.670 through 60.676 shall be submitted to both the U. S. Environmental Protection Agency and the Department. The Environmental Protection Agency copies may be sent to:

Director
Air Protection Division (3AP00)
U. S. EPA, Region III
1650 Arch Street
Philadelphia, PA 19103-2029

and

**SECTION D. Source Level Requirements**

The Pennsylvania Department of Environmental Protection
 Air Quality Program Manager
 208 W. Third Street, Suite 101
 Williamsport, PA 17701-6448

VI. WORK PRACTICE REQUIREMENTS.**# 010 [25 Pa. Code §127.441]****Operating permit terms and conditions.**

[Additional authority for this permit condition is derived from 25 Pa. Code Sections 127.1 and 127.12]

The permittee shall keep on hand a sufficient quantity of spare fabric collector bags for all fabric collectors (ID C105A through C105F) that control particulate matter emissions from Source ID P105, in order to be able to immediately replace any bags requiring replacement due to deterioration.

011 [25 Pa. Code §127.441]**Operating permit terms and conditions.**

The handling and storage of the material collected in all fabric collectors (ID C105A through C105F) that control particulate matter emissions from Source ID P105 shall not at any time result in the emission of fugitive air contaminants in excess of the limitations specified in 25 Pa. Code Section 123.1.

012 [25 Pa. Code §127.441]**Operating permit terms and conditions.**

The permittee shall not operate Source ID P105 without the simultaneous operation of the appropriate fabric collector(s) (IDs C105A through C105F).

VII. ADDITIONAL REQUIREMENTS.**# 013 [25 Pa. Code §127.441]****Operating permit terms and conditions.**

[Additional authority for this permit condition is derived from 25 Pa. Code Sections 127.1 and 127.12]

(a) The loadout spout on Silos #1 through #8 of Source ID P105 shall be controlled by the silo #6 bin vent filter (ID C105A).

(b) No more than two (2) of the loadout spouts shall be operating simultaneously at any given time and all loadout spouts not in actual use shall be gated or valved off from the fabric collector.

014 [25 Pa. Code §127.441]**Operating permit terms and conditions.**

[Additional authority for this permit condition is derived from 25 Pa. Code Sections 127.1 and 127.12]

The silo #6 bin vent filter and dust silo fabric collector (IDs C105A and ID C105E) shall be equipped with an air dryer and oil trap.

015 [25 Pa. Code §127.441]**Operating permit terms and conditions.**

(a) Source ID P105 Limestone Pulverizing Convey and Storage System which consists of the following equipment:

- One (1) Pulverizer Mill, Bradley Model 6000, 35 TPH
- One (1) Pulverizer Mill, Bradley Model H, 25 TPH
- One (1) Pulverizer Mill, Bradley Model 6000, 35 TPH
- One (1) Silo #6, Peabody Tec Tank, 800 Ton Capacity with load out spout
- One (1) Silo #1, Trico Industry, 600 Ton Capacity with load out spout
- One (1) Silo #2, Aglime, 250 Ton Capacity with an open truck load out spout
- Two (2) Silos #3 and #4, MFS, 150 Ton Capacity with load out spout
- One (1) Silo #5, Trico Industry, 500 Ton Capacity with load out spout
- One (1) Silo #7, Peabody Tec Tank, 1000 Ton Capacity with load out spout

**SECTION D. Source Level Requirements**

- One (1) Silo #8, Columbian Tec Tank, 1000 Ton Capacity with load out spout
- One (1) Screw Conveyor, 16" x 24', 35 TPH, 16B to 19C
- One (1) Screw Conveyor, 18" x 25', 25 TPH, 17 to 20
- One (1) Screw Conveyor, 18" x 20', 70 TPH, 20 to 23
- One (1) Screw Conveyor, 18" x 18', 10 TPH, 18 to 21A
- One (1) 18" Screw Conveyor, 21A to 8
- One (1) 18" Screw Conveyor, 8 to 21B
- One (1) 18" Screw Conveyor, 21B to 20
- One (1) Screw Conveyor, 18" x 25', 70 TPH, 20 to 19A
- One (1) Screw Conveyor, 12" x 50', 70 TPH, 21B to 33
- One (1) Screw Conveyor, 16" x 21.5', 70 TPH, 19C to 24
- One (1) Screw Conveyor, 14" x 31', 35 TPH, 25 to 27
- Two (2) Screw Conveyor, 12" x 12', 15 TPH, 28 to 30 and Air Sep to 28
- One (1) Screw Conveyor, 12" x 12', 25 TPH, 22 to 31
- One (1) Screw Conveyor, 18" x 65', 70 TPH, 19A to 36
- One (1) Screw Conveyor, 18" x 32', 70 TPH, 23 to 35
- One (1) Screw Conveyor, 6" x 24', 2 TPH, 99 to 33
- One (1) Screw Conveyor, 14" x 24', 70 TPH, 36 to 42
- One (1) Screw Conveyor, 12" x 19.5', 70 TPH, 36 to 43
- One (1) Screw Conveyor, 14" x 30', 70 TPH, 35 to 48
- One (1) Screw Conveyor, 14" x 50', 70 TPH, 35 to 50
- One (1) Bucket Elevator, 9" x 6" x 72', 70 TPH
- One (1) Bucket Elevator, 10" x 6" x 32', 25 TPH
- One (1) Bucket Elevator, 16" x 8" x 100', 70 TPH
- One (1) Bucket Elevator, 16" x 10" x 58', 70 TPH
- Three (3) Vibrating Feeders, FMC, 100 TPH
- One (1) Pneumatic Conveying System which discharges material from the fabric filter ID C106 to the Dust Silo Source ID P107 and consists of a Rotary Lobe Blower - Sutorbilt Model 711-V, One (1) Rotary Valve, Meyer, 10x10
- One (1) Dust Silo 50 Ton Capacity
- One (1) Water Blender, Paddle Conveyor, 20" x 12', 50 TPH

(b) ID C105A is a Fabric Collector, Dustex, Model 3430-9-14, 15,000 CFM

(c) ID C105B is a Bin Vent Filter, Kice, Model HRB-12-4 for Silo #6

(d) ID C105C is a Bin Vent Filter, C.P. Environmental, Model 84-BF-030-C for Silo #1, 2, 3, and 4

(e) ID C105D is a Bin Vent Filter, Kice, Model HRB-12-4, for Silo #7

(f) ID C105E is a Bin Vent Filter, Griffin Environmental Company, Model JV-36-4X for Silo #8

(g) ID C105F is a Fabric Collector, Alco, Model 25-72 for Dust Silo, 750 CFM

016 [25 Pa. Code §127.441]

Operating permit terms and conditions.

[Additional authority for this permit condition is derived from 25 Pa. Code Sections 127.1 and 127.12]

(a) The permittee shall use the loadout spouts associated with the silos of Source ID P105 (except Silo #2) to load tank trucks only.

(b) The permittee shall not load open top trucks from the loadout spouts associated with the silos of Source ID P105.

017 [40 CFR Part 60 Standards of Performance for New Stationary Sources §40 CFR 60.670]

Subpart 000 - Standards of Performance for Nonmetallic Mineral Processing Plants

Applicability and designation of affected facility.

The following equipment of Source ID P105 is subject to 40 CFR Part 60 Subpart 000:

**SECTION D. Source Level Requirements**

- Two (1) Pulverizer Mills, Bradley Model 6000, 35 TPH
- One (1) Silo #6, Peabody Tec Tank, 800 Ton Capacity with load out spout
- One (1) Silo #1, Trico Industry, 600 Ton Capacity with load out spout
- One (1) Silo #5, Trico Industry, 500 Ton Capacity with load out spout
- One (1) Silo #7, Peabody Tec Tank, 1000 Ton Capacity with load out spout
- One (1) Silo #8, Columbian Tec Tank, 1000 Ton Capacity with load out spout
- One (1) Screw Conveyor, 16" x 24', 35 TPH, 16B to 19C
- One (1) Screw Conveyor, 18" x 18', 10 TPH, 18 to 21A
- One (1) 18" Screw Conveyor, 21A to 8
- One (1) 18" Screw Conveyor, 8 to 21B
- One (1) 18" Screw Conveyor, 21B to 20
- One (1) Screw Conveyor, 18" x 25', 70 TPH, 20 to 19A
- One (1) Screw Conveyor, 12" x 50', 70 TPH, 21B to 33
- One (1) Screw Conveyor, 16" x 21.5', 70 TPH, 19C to 24
- One (1) Screw Conveyor, 14" x 31', 35 TPH, 25 to 27
- Two (2) Screw Conveyor, 12" x 12', 15 TPH, 28 to 30 and Air Sep to 28
- One (1) Screw Conveyor, 12" x 12', 25 TPH, 22 to 31
- One (1) Screw Conveyor, 18" x 65', 70 TPH, 19A to 36
- One (1) Screw Conveyor, 18" x 32', 70 TPH, 23 to 35
- One (1) Screw Conveyor, 6" x 24', 2 TPH, 99 to 33
- One (1) Screw Conveyor, 14" x 24', 70 TPH, 36 to 42
- One (1) Screw Conveyor, 12" x 19.5', 70 TPH, 36 to 43
- One (1) Screw Conveyor, 14" x 30', 70 TPH, 35 to 48
- One (1) Screw Conveyor, 14" x 50', 70 TPH, 35 to 50
- One (1) Bucket Elevator, 9" x 6" x 72', 70 TPH
- One (1) Bucket Elevator, 10" x 6" x 32', 25 TPH
- One (1) Bucket Elevator, 16" x 8" x 100', 70 TPH
- One (1) Bucket Elevator, 16" x 10" x 58', 70 TPH
- Three (3) Vibrating Feeders, FMC, 100 TPH
- One (1) Dust Silo 50 Ton Capacity
- One (1) Water Blender, Paddle Conveyor, 20" x 12', 50 TPH

(b) The permittee shall comply with all applicable requirements specified in 40 CFR Sections 60.670 through 60.676.

**SECTION D. Source Level Requirements**

Source ID: P106

Source Name: LIMESTONE DUST BUNKER

Source Capacity/Throughput:

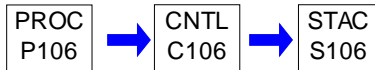
**I. RESTRICTIONS.****Emission Restriction(s).****# 001 [25 Pa. Code §127.441]****Operating permit terms and conditions.**

[Additional authority for this permit condition is derived from 25 Pa. Code Sections 127.1 and 127.12]

{Compliance with the requirement specified in this streamlined permit condition assures compliance with the provisions in 25 Pa. Code Section 123.13 and 40 CFR Part 60 Section 60.672}

The permittee shall not emit into the outdoor atmosphere of particulate matter, from the exhaust of the dust bunker bin vent filter (ID C106) associated with Source ID P106, in a manner that the concentration of particulate matter in the effluent gas exceeds 0.01 grains per dry standard cubic foot.

002 [25 Pa. Code §127.441]**Operating permit terms and conditions.**

[Additional authority for this permit condition is derived from 25 Pa. Code Sections 127.1 and 127.12]

{Compliance with the requirement specified in this streamlined permit condition assures compliance with the provisions in 25 Pa. Code Section 123.41}

There shall be no visible air contaminant emissions from the exhaust of the dust bunker bin vent filter (ID C106) associated with Source ID P106 other than water vapor or steam.

II. TESTING REQUIREMENTS.**# 003 [25 Pa. Code §127.441]****Operating permit terms and conditions.**

(a) The permittee shall comply with all applicable testing requirements as specified in 40 CFR Part 60 Subpart OOO Section 60.675 for Source ID P106.

(b) However, the permittee need not perform any opacity testing or stack testing unless specifically requested to do so by the Department or the U.S. Environmental Protection Agency.

III. MONITORING REQUIREMENTS.**# 004 [25 Pa. Code §127.441]****Operating permit terms and conditions.**

[Additional authority for this permit condition is derived from 25 Pa. Code Sections 127.1 and 127.12]

The dust bunker bin vent filter (ID C106) shall be equipped with instrumentation to monitor the differential pressure across ID C106 on continuous basis.

IV. RECORDKEEPING REQUIREMENTS.**# 005 [25 Pa. Code §127.441]****Operating permit terms and conditions.**

(a) The permittee shall record the differential pressure across the dust bunker bin vent filter (ID C106) at least once per day.

(b) These records shall be kept for a minimum of five (5) years and shall be made available to the Department upon

**SECTION D. Source Level Requirements**

request.

006 [40 CFR Part 60 Standards of Performance for New Stationary Sources §40 CFR 60.676]**Subpart 000 - Standards of Performance for Nonmetallic Mineral Processing Plants****Reporting and recordkeeping.**

The permittee shall comply with all applicable recordkeeping requirements as specified in 40 CFR Part 60 Subpart 000 Section 60.676 for Source ID P106.

V. REPORTING REQUIREMENTS.**# 007 [40 CFR Part 60 Standards of Performance for New Stationary Sources §40 CFR 60.4]****Subpart A - General Provisions****Address.**

The submission of all requests, reports, applications, submittals and other communications required by 40 CFR Part 60 Subpart 000 Sections 60.670 through 60.676 shall be submitted to both the U. S. Environmental Protection Agency and the Department. The Environmental Protection Agency copies may be sent to:

Director
Air Protection Division (3AP00)
U. S. EPA, Region III
1650 Arch Street
Philadelphia, PA 19103-2029

and

The Pennsylvania Department of Environmental Protection
Air Quality Program Manager
208 W. Third Street, Suite 101
Williamsport, PA 17701-6448

VI. WORK PRACTICE REQUIREMENTS.**# 008 [25 Pa. Code §127.441]****Operating permit terms and conditions.**

[Additional authority for this permit condition is derived from 25 Pa. Code Sections 127.1 and 127.12]

The permittee shall keep on hand a sufficient quantity of spare fabric collector bags for the dust bunker bin vent filter (ID C106), in order to be able to immediately replace any bags requiring replacement due to deterioration.

VII. ADDITIONAL REQUIREMENTS.**# 009 [25 Pa. Code §127.441]****Operating permit terms and conditions.**

[Additional authority for this permit condition is derived from 25 Pa. Code Sections 127.1 and 127.12]

All material deposited in Source ID P106 shall first be wetted in a pug mill or mixer.

010 [25 Pa. Code §127.441]**Operating permit terms and conditions.**

(a) Source ID P106 is a 20 foot x 20 foot concrete block dust storage bin ("dust bunker")

(b) ID C106 is a bin vent fabric collector, C.P.E. Filters, Inc. Model 84 BF 042C

**SECTION D. Source Level Requirements****# 011 [25 Pa. Code §127.441]****Operating permit terms and conditions.**

[Additional authority for this permit condition is derived from 25 Pa. Code Sections 127.1 and 127.12]

The access doors of Source ID P106 shall be kept closed at all times except when removing material from Source ID P106.

012 [25 Pa. Code §127.441]**Operating permit terms and conditions.**

[Additional authority for this permit condition is derived from 25 Pa. Code Sections 127.1 and 127.12]

The dust bunker bin vent filter (ID C106) shall control the particulate matter emissions from Source ID P106.

013 [25 Pa. Code §127.441]**Operating permit terms and conditions.**

[Additional authority for this permit condition is derived from 25 Pa. Code Sections 127.1 and 127.12]

The air compressor used to supply compressed air to the dust bunker bin vent filter (ID C106) shall be equipped with an air dryer and an oil trap.

014 [25 Pa. Code §127.441]**Operating permit terms and conditions.**

The permittee shall not operate Source ID P106 without the simultaneous operation of the dust bunker bin vent filter (ID C106).

015 [40 CFR Part 60 Standards of Performance for New Stationary Sources §40 CFR 60.670]**Subpart OOO - Standards of Performance for Nonmetallic Mineral Processing Plants****Applicability and designation of affected facility.**

(a) Source ID P106 is subject to 40 CFR Part 60 Subpart OOO Sections 60.670 through 60.676.

(b) The permittee shall comply with all applicable requirements as specified in 40 CFR Part 60 Subpart OOO Sections 60.670 through 60.676.

**SECTION D. Source Level Requirements**

Source ID: P201

Source Name: ASPHALT CONCRETE PLANT

Source Capacity/Throughput: 180.000 Tons/HR ASPHALT CEMENT

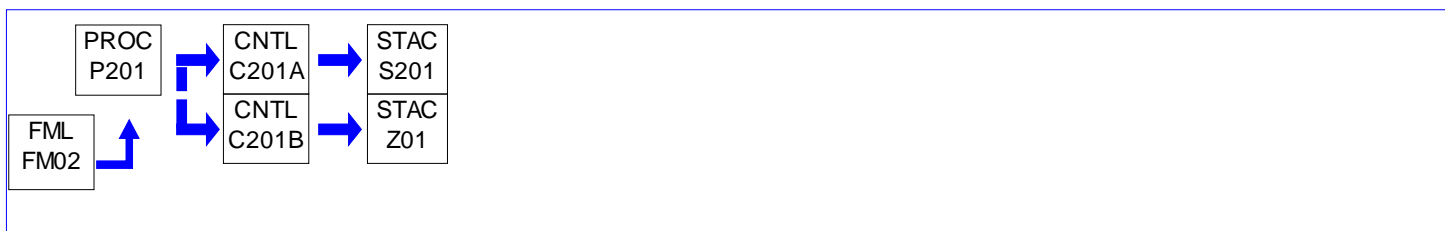
**I. RESTRICTIONS.****Emission Restriction(s).****# 001 [25 Pa. Code §123.13]****Processes**

The permittee shall not emit into the outdoor atmosphere of particulate matter, from the Aeropulse Bin Vent Filter (ID C201B) associated with Source ID P201, in a manner that the concentration of particulate matter in the effluent gas exceeds 0.04 grains per dry standard cubic foot.

002 [25 Pa. Code §123.21]**General**

[Compliance with the requirement specified in this streamlined permit condition assures compliance with the provision in 40 CFR 52.2020(c)]

No person may permit the emission of sulfur oxides expressed as SO₂, into the outdoor atmosphere from the rotary stone dryer burner and the Pug Mill heater of Source ID P201 in a manner that the concentration of the sulfur oxides in the effluent gas exceeds 500 parts per million, by volume, dry basis.

003 [25 Pa. Code §127.441]**Operating permit terms and conditions.**

[Additional authority for this permit condition is derived from 25 Pa. Code Sections 127.1 and 127.12]

[Compliance with this requirement specified in this streamlined permit condition assures compliance with the provisions in 25 Pa. Code Section 123.13]

The permittee shall not emit into the outdoor atmosphere of particulate matter from the Amerex Industries fabric collector (ID C201A) associated with Source ID P201 in a manner that the concentration of particulate matter in the effluent gas exceeds 0.02 grains per dry standard cubic foot.

004 [25 Pa. Code §127.441]**Operating permit terms and conditions.**

[Additional authority for this permit condition is derived from 25 Pa. Code Sections 127.1 and 127.12]

[Compliance with this requirement specified in this streamlined permit condition assures compliance with the provisions in 25 Pa. Code Section 123.41]

The permittee shall not emit visible air contaminants from any source of Source ID P201 in such a manner that the opacity of the emissions is equal to or greater than 10% opacity at any time.

Fuel Restriction(s).**# 005 [25 Pa. Code §127.441]****Operating permit terms and conditions.**

[Additional authority for this permit condition is derived from 25 Pa. Code Section 127.1 and 127.12]

**SECTION D. Source Level Requirements**

(a) Reclaimed/reprocessed oil used in Source ID P201 shall not contain contaminants in excess of the following limitations listed below:

- (1) Arsenic - 5 ppmw
- (2) Cadmium - 2 ppmw
- (3) Chromium - 10 ppmw
- (4) Lead - 100 ppmw
- (5) Total Halides - 1,000 ppmw
- (6) Polychlorinated Biphenyls (PCBs) - Non Detectable (minimum detection limit of 2 ppmw)

(b) The sulfur content of any virgin No. 2 fuel oil, reclaimed/reprocessed oil, and/or blend of reclaimed/reprocessed/virgin oil fired in any source at this facility, shall not exceed 0.5%, by weight.

(c) The heat content of the reclaimed/reprocessed oil used in Source ID P201 shall not be less than 136,000 Btu per gallon and the flash point shall not be less than 100 degrees Fahrenheit.

(d) The permittee shall not accept for use in Source ID P201 any shipment of reclaimed/reprocessed oil for which the arsenic, cadmium, chromium, lead, total halides, polychlorinated biphenyls (PCBs), Btu per gallon heat content, sulfur content and flash points are unknown or which fails to meet any of the limitation as specified above.

006 [25 Pa. Code §127.441]**Operating permit terms and conditions.**

[Additional authority for this permit condition is derived from 25 Pa. Code Sections 127.1 and 127.12]

The permittee shall not, under any circumstances, fire waste oil in the rotary stone dryer burner or the pug mill heater of Source ID P201.

007 [25 Pa. Code §127.441]**Operating permit terms and conditions.**

[Additional authority for this permit condition is derived from 25 Pa. Code Sections 127.1 and 127.12]

(a) The permittee shall only fire in Source ID P201 virgin No. 2 fuel oil, reclaimed/reprocessed oil, and/or a blend of reclaimed/reprocessed/virgin oil with a sulfur content not to exceed 0.5%, by weight, at any time.

(b) The permittee shall not accept for use in Source ID P201 any shipment of reclaimed/reprocessed oil for which the sulfur content is unknown or which fails to meet the limitation as specified above.

Throughput Restriction(s).**# 008 [25 Pa. Code §127.441]****Operating permit terms and conditions.**

[Additional authority for this permit condition is derived from 25 Pa. Code Sections 127.1 and 127.12 and the permittee requesting this Synthetic Minor restriction]

The permittee shall not fire more than 1,338,480 gallons of No. 2 virgin fuel oil, reclaimed/reprocessed oil, or a blend of reclaimed/reprocessed/No. 2 virgin fuel oil in Source ID P201 in any 12 consecutive month period.

II. TESTING REQUIREMENTS.

No additional testing requirements exist except as provided in other sections of this permit including Section B (State Only General Requirements).

**SECTION D. Source Level Requirements****III. MONITORING REQUIREMENTS.****# 009 [25 Pa. Code §127.441]****Operating permit terms and conditions.**

[Additional authority for this permit condition is derived from 25 Pa. Code Sections 127.1 and 127.12]

The Amerex Industries fabric collector (ID C201A) and the Aeropulse Bin Vent Filter (ID C201B) shall be equipped with instrumentation to monitor the differential pressure across each collector on a continuous basis.

IV. RECORDKEEPING REQUIREMENTS.**# 010 [25 Pa. Code §127.441]****Operating permit terms and conditions.**

(a) The permittee shall keep records of the following:

(1) The number of hours that Source ID P201 is operated each month,

(2) The amount of virgin No. 2 fuel oil, reclaimed/reprocessed oil, and/or a blend of virgin No. 2 fuel/reclaimed/reprocessed oil fired each month in Source ID P201 to verify compliance with the throughput limitation in any 12 consecutive month period,

(3) The pressure drop across the Amerex Industries fabric collector and the Aeropulse Bin Vent Filter (IDs C201A and ID C201B) associated with Source ID P201 at least once per day.

(b) These records shall be retained for a minimum of five (5) years and be made available to the Department upon request.

V. REPORTING REQUIREMENTS.**# 011 [25 Pa. Code §127.441]****Operating permit terms and conditions.**

(a) The permittee shall submit an annual report to the Department on the 12 month rolling total of the amount of virgin No. 2 fuel oil, reclaimed/reprocessed oil, and/or a blend of virgin No.2 fuel/reclaimed/reprocessed oil fired in Source ID P201 for each month.

(b) The annual report shall be submitted to the Department by no later than March 1 (for reporting months of January through December of the previous year) for the 12 consecutive month period.

VI. WORK PRACTICE REQUIREMENTS.**# 012 [25 Pa. Code §127.441]****Operating permit terms and conditions.**

[Additional authority for this permit condition is derived from 25 Pa. Code Sections 127.1 and 127.12]

The permittee shall keep on hand a sufficient quantity of spare fabric collector bags for the Amerex Industries fabric collector and the Aeropulse Bin Vent Filter (IDs C201A and C201B), in order to be able to immediately replace any bags requiring replacement due to deterioration.

013 [25 Pa. Code §127.441]**Operating permit terms and conditions.**

The handling and storage of the material collected in the Amerex Industries fabric collector and the Aeropulse Bin Vent Filter (IDs C201A and C201B) shall not at any time result in the emission of fugitive air contaminants in excess of the limitations specified in 25 Pa. Code Section 123.1.

014 [25 Pa. Code §127.441]**Operating permit terms and conditions.**

[Additional authority for this permit condition is derived from 25 Pa. Code Sections 127.1 and 127.12]

The compressed air supply to the Amerex Industries Amerex Industries fabric collector (ID C201A) and the Aeropulse Bin

**SECTION D. Source Level Requirements**

Vent Filter (ID C201B) shall be equipped with an air dryer and oil trap.

VII. ADDITIONAL REQUIREMENTS.**# 015 [25 Pa. Code §127.441]****Operating permit terms and conditions.**

[Additional authority for this permit condition is derived from 25 Pa. Code Sections 127.1 and 127.12]

The permittee shall not use the rotary stone dryer of Source ID P201 to dry any aggregate material, other than when Source ID P201 is simultaneously producing asphalt concrete.

016 [25 Pa. Code §127.441]**Operating permit terms and conditions.**

[Additional authority for this permit condition is derived from 25 Pa. Code Sections 127.1 and 127.12]

The permittee shall not use Source ID P201 to process Recycled Asphalt Pavement (RAP), at any time.

017 [25 Pa. Code §127.441]**Operating permit terms and conditions.**

[Additional authority for this permit condition is derived from 25 Pa. Code Sections 127.1 and 127.12]

The permittee shall not use Source ID P201 to decontaminate, or otherwise treat soil or any other material which has been contaminated with gasoline, fuel oil, or any other substance.

018 [25 Pa. Code §127.441]**Operating permit terms and conditions.**

[Additional authority for this permit condition is derived from 25 Pa. Code Sections 127.1 and 127.12]

The permittee shall not use Source ID P201 to produce asbestos-containing asphalt material.

019 [25 Pa. Code §127.441]**Operating permit terms and conditions.**

(a) Source ID P201 is a 180 ton/hr Madson batch asphalt concrete plant which consists of the following equipment:

- (1) Four (4) Raw Aggregate Stockpiles
- (2) Five (5) Cold Feed Bins, 25 Tons
- (3) Five (5) Feeders, 30" x 8', 200 TPH
- (4) One (1) Belt Conveyor, 24" x 75', 200 TPH
- (5) One (1) Belt Conveyor, 24" 58', 200 TPH
- (6) One (1) Madson Rotary Stone Dryer, Model 604 with integral burner, No. 2 fuel oil fired, Hauck Model Eco Star 75, 54.6 MMBtu/hr Rated Heat Input
- (7) One (1) Dust Silo, 50 Tons
- (8) One (1) Batch Tower which consists of the following:
 - (i) One (1) Screen, Dister, Model UHS-4510 DDS, 180 TPH
 - (ii) One (1) Bucket Elevator, Madson, 16" x 8" X 60', 180 TPH

**SECTION D. Source Level Requirements**

(iii) One (1) Pug Mill, Madson Size 6000, 180 TPH

(iv) One (1) reclaimed/reprocessed/virgin oil-fired Pug Mill Heater, Sellers, Model SF01.3, 1.3 MMBtu/hr rated heat input

(v) Two (2) Screw Conveyors, 9" x 23 =', 20 TPH

(9) One (1) Pneumatic Conveying System which discharges material from the fabric filter ID C201A to the Dust Silo Source ID P201 and consists of a Rotary Lobe Blower - Sutorbilt Model 711, Two (2) Rotary Valves, Rotolok, 10x10

(b) ID C201A is a Fabric Filter, Amerex Industries, Model RP-10-465, 46,000 CFM

(c) ID C201B is a Fabric Filter, Aeropulse, Model SB-16-6-N, 600 CFM

020 [25 Pa. Code §127.441]

Operating permit terms and conditions.

(a) Particulate matter emissions from all equipment of Source ID P201, excluding the pneumatic conveying system to convey dust from the Amerex Industries fabric collector (ID C201A) to the dust silo, shall be controlled by ID C201A

(b) Particulate matter emissions from the pneumatic conveying system of Source ID P201 shall be controlled by the Aeropulse Bin Vent Filter (ID C201B)

**SECTION D. Source Level Requirements**

Source ID: P301

Source Name: FIVE (5) ABOVEGROUND STORAGE TANKS

Source Capacity/Throughput:

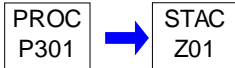
**I. RESTRICTIONS.****Emission Restriction(s).****# 001 [25 Pa. Code §127.441]****Operating permit terms and conditions.**

The permittee shall not store any liquid containing volatile organic compounds (VOC) with a vapor pressure greater than 1.5 psia (10 kilopascals) under actual storage conditions in any tank of Source ID P301.

II. TESTING REQUIREMENTS.

No additional testing requirements exist except as provided in other sections of this permit including Section B (State Only General Requirements).

III. MONITORING REQUIREMENTS.

No additional monitoring requirements exist except as provided in other sections of this permit including Section B (State Only General Requirements).

IV. RECORDKEEPING REQUIREMENTS.**# 002 [25 Pa. Code §127.441]****Operating permit terms and conditions.**

(a) The permittee shall keep records of the vapor pressure of the contents in any tank of Source ID P301.

(b) These records shall be retained for a minimum of five (5) years and shall be made available to the Department upon request.

V. REPORTING REQUIREMENTS.

No additional reporting requirements exist except as provided in other sections of this permit including Section B (State Only General Requirements).

VI. WORK PRACTICE REQUIREMENTS.

No additional work practice requirements exist except as provided in other sections of this permit including Section B (State Only General Requirements).

VII. ADDITIONAL REQUIREMENTS.**# 003 [25 Pa. Code §127.441]****Operating permit terms and conditions.**

Source ID P301 consists of five (5) aboveground storage tanks which consists of the following:

(a) One (1) Tank, Diesel Fuel, 10,000 Gallon Capacity

(b) Two (2) Tanks, Asphalt Cement, 20,000 Gallon Capacity Each

(c) One (1) Tank, Heating Oil for Pug Mill Heater, 10,000 Gallon Capacity

**SECTION D. Source Level Requirements**

(d) One (1) Tank, Reclaimed Oil, 20,000 Gallon Capacity

**SECTION D. Source Level Requirements**

Source ID: P302

Source Name: ONE (1) PARTS CLEANING STATION

Source Capacity/Throughput:

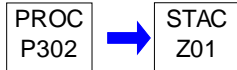
**I. RESTRICTIONS.**

No additional requirements exist except as provided in other sections of this permit including Section B (State Only General Requirements).

II. TESTING REQUIREMENTS.

No additional testing requirements exist except as provided in other sections of this permit including Section B (State Only General Requirements).

III. MONITORING REQUIREMENTS.

No additional monitoring requirements exist except as provided in other sections of this permit including Section B (State Only General Requirements).

IV. RECORDKEEPING REQUIREMENTS.**# 001 [25 Pa. Code §129.63]****Degreasing operations**

The permittee shall keep for a minimum of five (5) years and make available to the Department upon request the following information:

- (1) The name and address of the solvent supplier,
- (2) The type of solvent including the product or vendor identification number,
- (3) The vapor pressure of the solvent measured in mm of Hg at 68 degrees F.

V. REPORTING REQUIREMENTS.

No additional reporting requirements exist except as provided in other sections of this permit including Section B (State Only General Requirements).

VI. WORK PRACTICE REQUIREMENTS.**# 002 [25 Pa. Code §129.63]****Degreasing operations**

Each solvent cleaning sink of Source ID P302 shall have the following:

- (1) A permanent conspicuous label summarizing these operating requirements:
 - (a) Waste solvent shall be collected and stored in a closed container. The closed container may contain a device that allows pressure relief, but does not allow liquid solvent to drip from the container.
 - (b) Flushing of Parts using a flexible hose or other flushing device shall be performed only within the cold cleaning machine. The solvent spray shall be a solid fluid stream, not an atomized or shower spray.
 - (c) Sponges, fabric, wood, leather, paper products, and other absorbent materials may not be cleaned in the cold cleaning

**SECTION D. Source Level Requirements**

machine.

(d) Air agitated solvent baths may not be used.

(e) Spills during solvent transfer and use of cold cleaning machine shall be cleaned up immediately.

(2) In addition, the label shall include the following discretionary good operating practices:

(a) Cleaned parts should be drained at least 15 seconds or until dripping ceases, whichever is longer. Parts having cavities or blind holes shall be tipped or rotated while the part is draining.

(b) During the draining, tipping or rotating, the parts should be positioned so that solvent drains directly back to the cold cleaning machine.

(c) Work area fans should be located and positioned so that they do not blow across the opening of the degreaser unit.

VII. ADDITIONAL REQUIREMENTS.

003 [25 Pa. Code §127.441]

Operating permit terms and conditions.

Source ID P302 is one (1) Parts Cleaning Station, Garage Area, Snap-on Tools Model YDM132, 30 Gallon reservoir, 22" x 32" x 10", Closeable Lid

004 [25 Pa. Code §129.63]

Degreasing operations

The vapor pressure of VOC containing solvent shall be less than 1.0 millimeter of mercury (mm Hg) measured at 20 degrees Celsius (68 degrees Fahrenheit)

005 [25 Pa. Code §129.63]

Degreasing operations

Source ID P302 is subject to 25 Pa. Code Section 129.63(a) (Degreasing Operations - Cold Cleaning Machines). The permittee shall comply with all applicable requirements specified in 25 Pa. Code Section 129.63(a).

**SECTION D. Source Level Requirements**

Source ID: P401

Source Name: PORTABLE SCREENING

Source Capacity/Throughput:

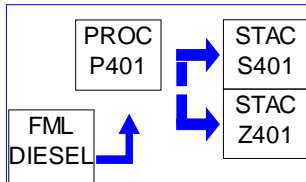
**I. RESTRICTIONS.****Emission Restriction(s).****# 001 [25 Pa. Code §123.13]****Processes**

(c) For processes not listed in subsection 25 Pa Code 123.13(b)(1) the following shall apply:

(1) Prohibited emissions. No person may permit the emission into the outdoor atmosphere of particulate matter from any process not listed in subsection 123.13(b)(1) in a manner that the concentration of particulate matter in the effluent gas exceeds 0.04 grain per dry standard cubic foot, when the effluent gas volume is less than 150,000 dry standard cubic feet per minute.

002 [25 Pa. Code §123.21]**General**

No person may permit the emission into the outdoor atmosphere of sulfur oxides from a source in a manner that the concentration of the sulfur oxides, expressed as SO₂, in the effluent gas exceeds 500 parts per million, by volume, dry basis.

Fuel Restriction(s).**# 003 [25 Pa. Code §127.441]****Operating permit terms and conditions.**

The engine associated with Source ID P401 shall only be operated with diesel fuel containing maximum sulfur by weight equal to 15 ppm.

II. TESTING REQUIREMENTS.

No additional testing requirements exist except as provided in other sections of this permit including Section B (State Only General Requirements).

III. MONITORING REQUIREMENTS.**# 004 [25 Pa. Code §127.441]****Operating permit terms and conditions.**

A non-resettable hour meter shall monitor the hours of operation of the engine associated with Source ID P401.

IV. RECORDKEEPING REQUIREMENTS.**# 005 [25 Pa. Code §127.441]****Operating permit terms and conditions.**

As required in 40 CFR Part 60 Subpart IIII, the permittee shall maintain record of the maintenance activities performed on the engine to verify that it is maintained in accordance with the manufacturer's emissions-related written instructions.

006 [25 Pa. Code §127.441]**Operating permit terms and conditions.**

(1) The permittee shall keep records through the non-resettable hour meter of the monthly hours of operation of the engine.

**SECTION D. Source Level Requirements**

(2) The permittee shall keep records of the location of each screening operation to verify that the portable designation of the engine remains valid.

007 [25 Pa. Code §127.441]

Operating permit terms and conditions.

The permittee shall keep record of the emission calculations for the engine that verifies the source meets the standards at 25 Pa. Code Sections 123.11 and 123.21.

008 [25 Pa. Code §127.441]

Operating permit terms and conditions.

The permittee shall keep the fuel receipt and certification records verifying the fuel used in the engine associated with Source ID P401 is diesel containing no more than 15 ppm by weight of sulfur.

009 [25 Pa. Code §127.441]

Operating permit terms and conditions.

The records required for Source ID P401 shall kept for a period of 5 years and made available to the Department upon request.

V. REPORTING REQUIREMENTS.

No additional reporting requirements exist except as provided in other sections of this permit including Section B (State Only General Requirements).

VI. WORK PRACTICE REQUIREMENTS.

010 [25 Pa. Code §127.441]

Operating permit terms and conditions.

Visible dust emissions from operation of the portable screener shall be minimized at all times by processing only wet material through the screener and by taking actions, as necessary. These actions include, but not limited to, use of water (where available) or chemicals; application of asphalt, oil, water or suitable chemicals on dirt roads, piles and other surfaces that may give rise to airborne dust; paving and maintenance of roadways; prompt removal of earth or other material from paved streets onto which earth or other material has been transported by trucking or earth moving equipment, erosion by water, or other means.

VII. ADDITIONAL REQUIREMENTS.

011 [25 Pa. Code §127.441]

Operating permit terms and conditions.

The engine associated with Source ID P401 is subject to the National Standards of Performance for Stationary Sources as codified in 40 CFR Part 60 Subpart IIII. The permittee shall comply with all applicable requirements for the engine, as specified in 40 CFR Sections 60.4200 through 60.4219.

012 [25 Pa. Code §127.441]

Operating permit terms and conditions.

Source ID P401 is a vibratory screening operation that includes, but not limited to, a portable screener equipped with a 99.2 hp diesel-fired engine.



SECTION E. Source Group Restrictions.

**SECTION F. Alternative Operation Requirements.**

No Alternative Operations exist for this State Only facility.

**SECTION G. Emission Restriction Summary.**

No emission restrictions listed in this section of the permit.

**SECTION H. Miscellaneous.**

The following air contaminant sources are considered to be of minor significance to the Department and have been determined to be exempt from permitting requirements. However, this determination does not exempt the sources from compliance with all applicable air quality regulations specified in 25 Pa. Code Chapters 121-145:

- (a) One (1) Tank, Used Motor Oil, Aboveground, 1,000 Gallon Capacity
- (b) One (1) Tank, Heating Oil, Aboveground, 1,000 Gallon Capacity
- (c) One (1) Tank, Heating Oil, Underground, 2,000 Gallon Capacity
- (d) One (1) Tank, New Motor Oil, Underground, 3,000 Gallon Capacity
- (e) One (1) Tank, Unleaded Gasoline, Underground, 3,000 Gallon Capacity
- (f) One (1) Tank, Reclaimed Oil, Underground, 10,000 Gallon Capacity
- (g) One (1) Tank, Diesel Fuel, Underground, 15,000 Gallon Capacity
- (h) One (1) Portable Power Washer, MI-T-Hot Model HW-2004-OME1



***** End of Report *****
